

Mastercam®

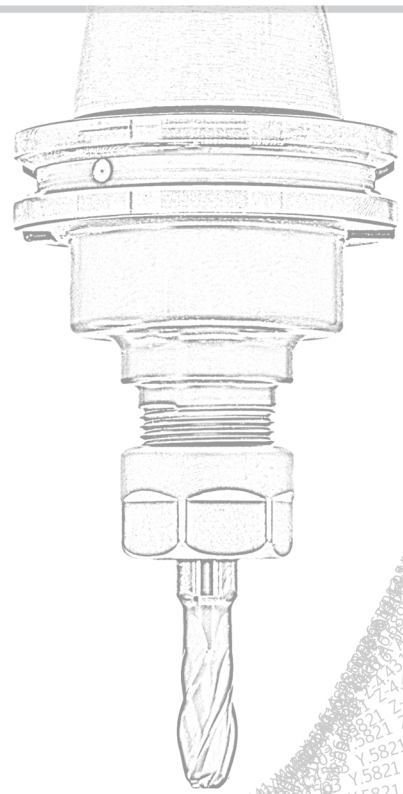

What's New in Mastercam 2024

May 2023



What's New in Mastercam 2024

May 2023

© 2023 CNC Software, LLC - All rights reserved.

Software: Mastercam 2024

Terms of Use

Use of this document is subject to the Mastercam End User License Agreement. The Mastercam End User License Agreement can be found at:

<https://www.mastercam.com/legal/>

Be sure you have the latest information!

Information might have changed or been added since this document was published. The latest version of the document is installed with Mastercam or can be obtained from your local Reseller. The Resolved Issues website—installed with each release—includes the latest information about Mastercam features and enhancements.

Table of Contents

Table of Contents	3
Introduction	7
Release Highlights	7
Mastercam Resources	7
Contact Us	8
Milling Enhancements	9
Cutting Holes Based on Previously Defined Processes	9
Viewing Graphical Planes and Geometry Color with Toolpaths	10
Viewing Linking Parameter Planes	10
Setting and Viewing the Color of Selected Geometry	12
Maximizing Your Tool Engagement	13
Viewing Your Selection Count for Hole Making and Multiaxis Toolpaths	14
Smoother Milling Toolpath Motion	15
Including Add-In Functionality to the Swept 2D Toolpath	16
2D Toolpath Enhancements	16
Area Mill Enhancements	16
Machining with Open and Closed Contour Directions	17
Setting Lead Motion	17
Outputting Feed Moves and Fitting Arc Moves	18
Overriding Your Feed Rate When Cutting Around Corners	18
Reducing Tool Wear When Using Roll In	19
Creating Smooth Tool Motion in Sharp Corners for Contour Remachining	20
Hole Making Toolpath Enhancements	20
Process Hole	20
Consolidating Parameter Locations	22
3D Toolpath Enhancements	22
Controlling Your Cut Order for Raster Toolpaths	23
Setting First/Last Leads for 3D High Speed Finishing Toolpaths	23

Machining Flat Areas with Area Roughing	24
Setting the Minimum Clearance Distance when Retracting	25
Dynamic OptiRough Improvements	25
Using the Same Wall and Floor Stock Values for 3D Toolpaths	25
Reversing the Cut Order	26
Detecting Undercut Stock When Machining	26
Removing Excess Material with Blend Toolpaths	27
Controlling Tool Motion in Shallow Part Areas	27
Selecting Regions to Avoid for Pencil Toolpaths	28
Multiaxis Toolpath Enhancements	28
Pocketing and Roughing for 3-Axis	28
Pocketing for Automatic Tool Axis Control	28
Collision Checking for Blade Expert	29
Deburr Enhancements	29
Specifying the Cut Type	29
Avoiding Contact Point on Tip	31
New Supported Tool Types	32
Load Save Defaults	32
Machining Angle Controls	33
New Machine Angle Controls Supported Plane Types	34
Straighten cuts on boundaries	34
Turning Enhancements	37
B-Axis Contour Turning Enhancements	37
Editing the Toolpath Vectors	37
Manually Defining the Usable Portion of the Insert	40
Adjusting the Stock	42
Using Turret-Mounted Angled Milling Heads	43
Using Angled Milling Heads in Operations	44
Tool Locator Components	46
Creating a New Spindle Origin for Spindle Move Operations	49

Creating Separate Lead In/Out Moves for Semi-Finishing Passes	51
Enhancements to Variable Depth of Cut for Lathe Rough	51
Designing Enhancements	53
Controlling the Orientation of Disassembled Solids or Mesh Bodies	53
Solid Hole Enhancements	54
Easily Smooth the Edges of Solid Holes	54
Creating New Operations from a Single Hole Operation	54
Changing the Direction of Existing Through Holes	56
Modifying Your Drafting Dimensions Directly	56
Trim, Break, and Extend Wireframe Entities from One Function	58
Smoothly Attach Spline Endpoints	59
Note Workflow Improvement	59
Simulation Enhancements	61
New Mastercam Simulator Workflow for Mill and Router Machines	61
Exporting Collision Reports	63
Improved Move List Pane	63
Checking Your Tool Orientation During Simulation	64
Viewing Tool Tip Positions and Comments	65
Setting Custom Background Colors	65
Toolpath Utility Enhancements	67
Changing the WCS, Cplane, or Tplane of Selected Operations	67
System Enhancements	69
Controlling Your Graphics View with the Gview Cube	69
Reversing a Chain or Changing Its Side in the Graphics Area	70
Warning of Corrupt Planes	71
System Configuration Enhancements	71
Updated Screen and Spin Controls Pages	71
Setting Import and Export Options	72
Unblank Parent Surfaces Option	73
Adjusting the Translucency of Glass and Outlined Entities	74

Machine Systems Enhancements	75
Accessing Machine Definition Parameters in MP.NET	75
Api.MachineDefInfo function	75
Api.AxisCombo function	75
Specifying the component type	76
Api.GetRelatedComponentID function	77
Machine Group Setup Enhancements	77
Viewing the Page Status	78
Viewing Stock Dimensions	79
New Stock Selection Methods	80
Pushing and Pulling Your Stock	81
Overriding Your Stock	81
Creating Mill-Turn Coolant Strategies	82
Working with the Coolant Strategy Editor	83
Enhancing MCO Conversion Options for Component Models	85
New Options for Creating Multi-Stream Views	86
Duplicating Existing Part Handling Strategies	87
File Management Enhancements	89
Working with Content Files	89
Updating Content Files	89
Opening and Extracting PDF Files	89
Replacing and Extracting Files	90
Posts and Machine Environments	91
Generic .machine Files Can No Longer be Migrated	91
New Posts and Machines for Mastercam 2023	91

Introduction

Welcome to What's New in Mastercam 2024! Mastercam 2024 features new functionality focused on delivering speed and efficiency to your machining jobs.

Release Highlights

Only have a few minutes? Listed below are a few of the highlights from this release:

- ["Cutting Holes Based on Previously Defined Processes "](#) on page 9
- ["B-Axis Contour Turning Enhancements"](#) on page 37
- ["Trim, Break, and Extend Wireframe Entities from One Function "](#) on page 58
- ["New Options for Creating Multi-Stream Views"](#) on page 86
- ["Viewing Graphical Planes and Geometry Color with Toolpaths"](#) on page 10
- ["Controlling Your Graphics View with the Gview Cube "](#) on page 69
- ["Using Turret-Mounted Angled Milling Heads"](#) on page 43
- ["Creating a New Spindle Origin for Spindle Move Operations "](#) on page 49
- ["Solid Hole Enhancements"](#) on page 54

Mastercam Resources

Enhance your Mastercam 2024 experience by using the following resources:

- *Mastercam Documentation*—Mastercam installs a number of helpful documents for your version of software in the Documentation folder of your Mastercam installation.
- *Mastercam Help*—Access Mastercam Help by selecting **Help**, **Contents** from Mastercam's **File** tab or by pressing **[Alt+H]** on your keyboard.
- *Mastercam Reseller*—Your local Mastercam Reseller can help with most questions about Mastercam.
- *Technical Support*—Our Technical Support department (+1 860-875-5006 or support@mastercam.com) is open Monday through Friday from 8:00 a.m. to 5:30 p.m. USA Eastern Standard Time.
- *Mastercam Tutorials*—We offer a series of tutorials to help registered users become familiar with basic Mastercam features and functions. Visit our website, or select **Help**, **Tutorials** from Mastercam's **File** tab to see the latest publications.
- *Mastercam University*—Mastercam University, an affordable online learning platform, gives you 24/7 access to Mastercam training materials. Take advantage of our many videos to master skills at your own pace and help prepare for Mastercam Certification. For more information on Mastercam University, please contact your Authorized Mastercam Reseller, visit university.mastercam.com/, or email training@mastercam.com.
- *Online Communities*—You can find a wealth of information at www.mastercam.com.
 - Follow us on Facebook (www.facebook.com/Mastercam), Twitter (twitter.com/Mastercam), and Instagram (<https://www.instagram.com/mastercam/>) for the latest tech tips and Mastercam news.
 - See Mastercam in action on YouTube (www.youtube.com/user/MastercamCadCam).

- For more information on CNC Software, LLC, to find and apply to jobs, and connect with people using Mastercam, visit us on LinkedIn (www.linkedin.com/company/cnc-software/).
- Registered users can search for information or ask questions on the Mastercam Web forum, forum.mastercam.com, or use the Mastercam Knowledgebase at kb.mastercam.com.

Contact Us

For questions about this or other Mastercam documentation, contact the Technical Documentation Department by email at techdocs@mastercam.com.

Milling Enhancements

Listed below are major enhancements to the Mill product. These include improvements to 2D, 3D, and Multiaxis toolpaths.



NOTE

Unless otherwise stated, the new features and functionality listed in this section apply to both Mill and Router licenses.

Cutting Holes Based on Previously Defined Processes

The Process Hole toolpath is located on the Toolpaths tab for mill and router machines.

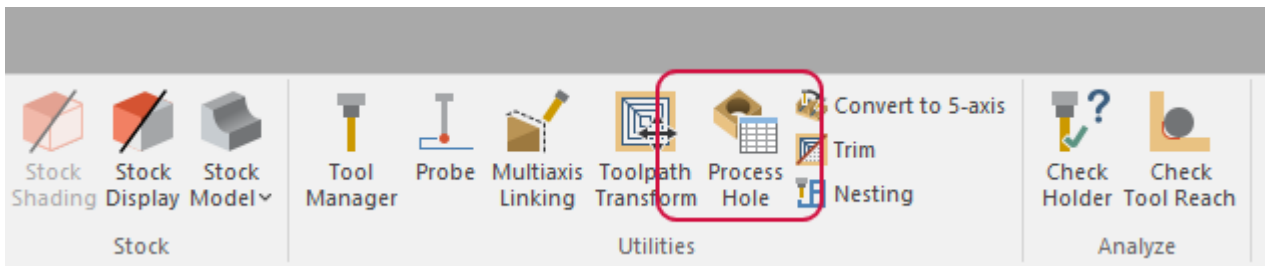

The Process Hole toolpath applies previously defined processes to a part's solid hole features. A process consists of one or more hole-making operations that you build in an operations library. You can import applicable processes into the working part file when creating a Process Hole operation to make your operations quicker and repeatable.

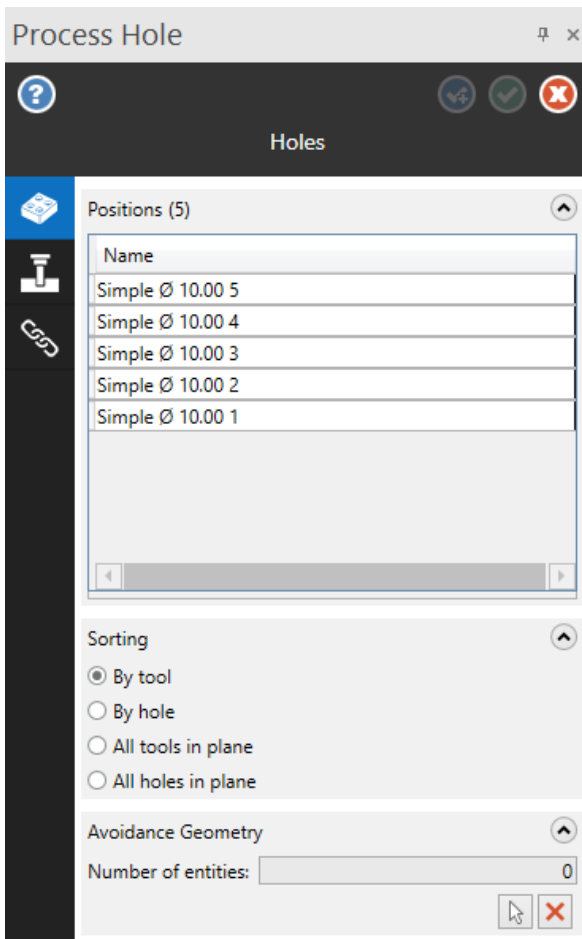

The operations library controls tool type and number, feeds and speeds, and operation order. The Process Hole operation determines geometry selection and linking parameters. You can use both 3- and 5-axis scenarios for Process Hole geometry selection. At any point after creating a Process Hole operation, you can explode the operation into its component operations and work directly with those components like any other toolpath.

Viewing Graphical Planes and Geometry Color with Toolpaths

A **Display graphical elements** button has been added to hole-making and multiaxis toolpath dialog boxes. This control allows you to show or hide graphical elements such as selected geometry colors and graphical planes, depending on the toolpath type.

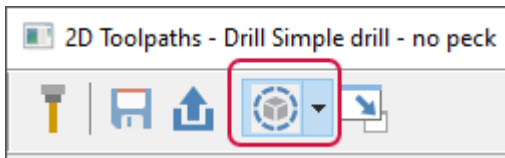

Viewing Linking Parameter Planes

When you create a hole-making toolpath, Mastercam can now display on-screen indicators of plane types and values. Use the **Display graphical elements** button to turn on graphical elements. Then, in the **Linking Parameters** page, select the planes indicators you want to display in the graphics window, as shown in the following image.

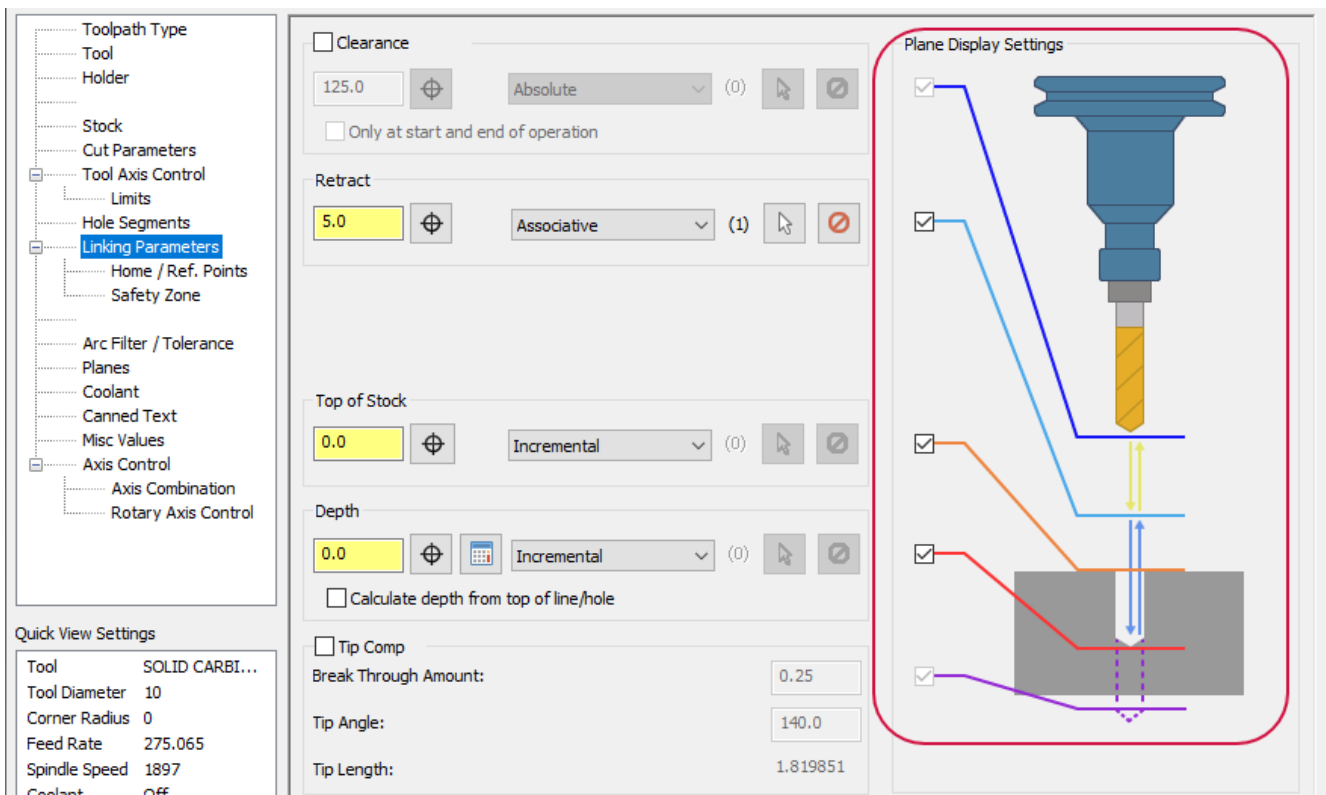

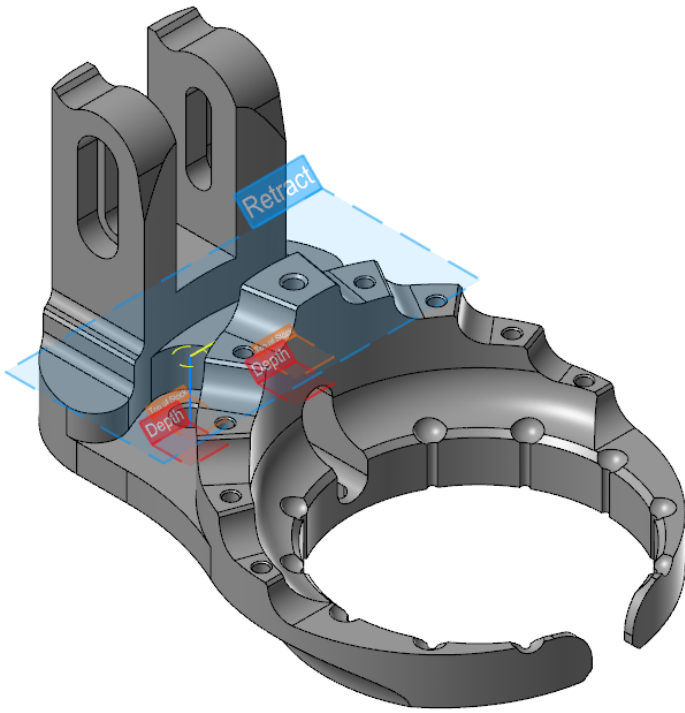

When you change values in the dialog box, Mastercam updates the graphical planes in the graphics window. You can also change the position and value of a plane by dragging its graphical representation in the graphics window, as shown in the following image. During this dragging, you can type a value into the box that appears with the gnomon. Additionally, you can drag the plane indicator to an Auto Cursor point.

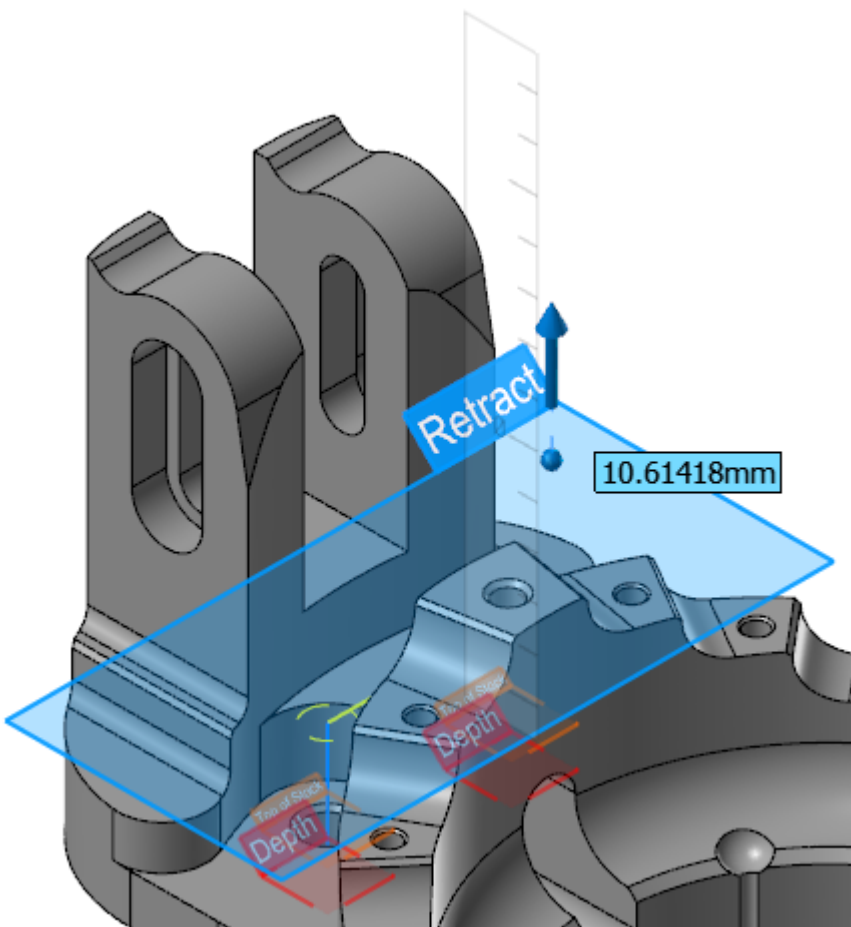

By turning off the **Display plane labels** option in the **Display graphical elements** drop-down, you can remove the labels from the plane indicators, leaving you with a simpler display. When the labels are off, you can hover your cursor over a plane to see its label.

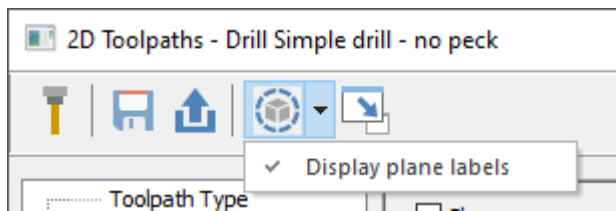

Setting and Viewing the Color of Selected Geometry

You can now set the color of selected geometry in the graphics window for multiaxis toolpaths within the **Cut Pattern Dialog** box. The selected color remains in effect as long as you are in the dialog box. You can also use color with collision control groups and cut pattern rows. Change the color by clicking the color box and selecting a new color from the **Colors** dialog box.

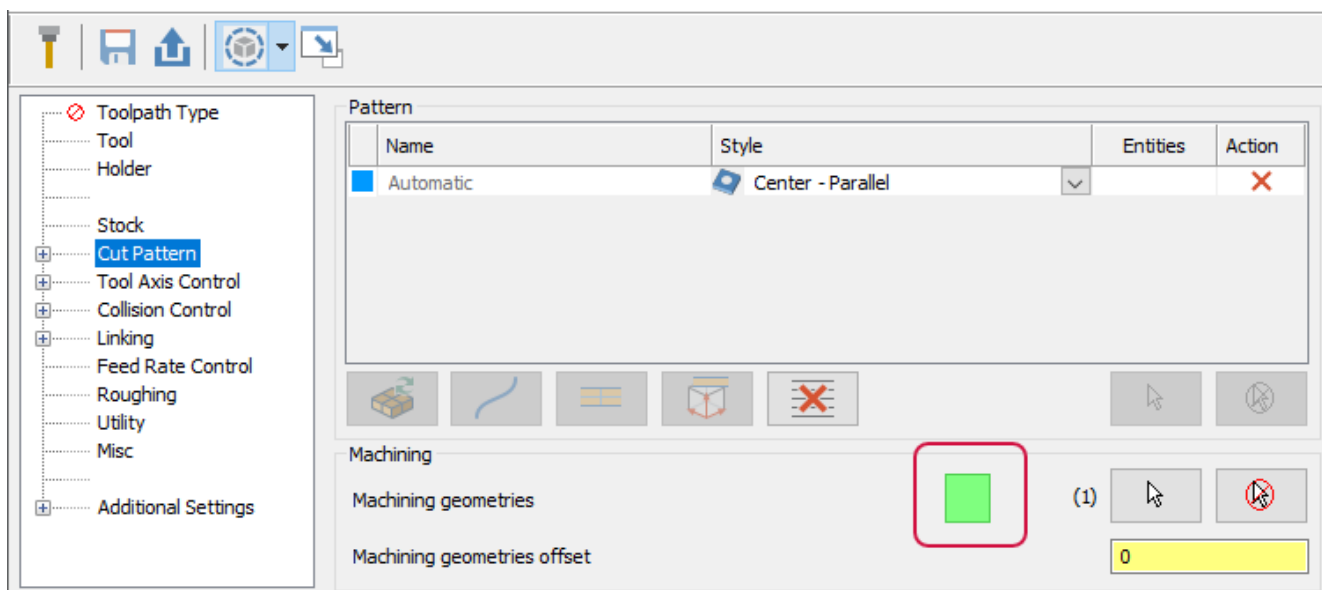

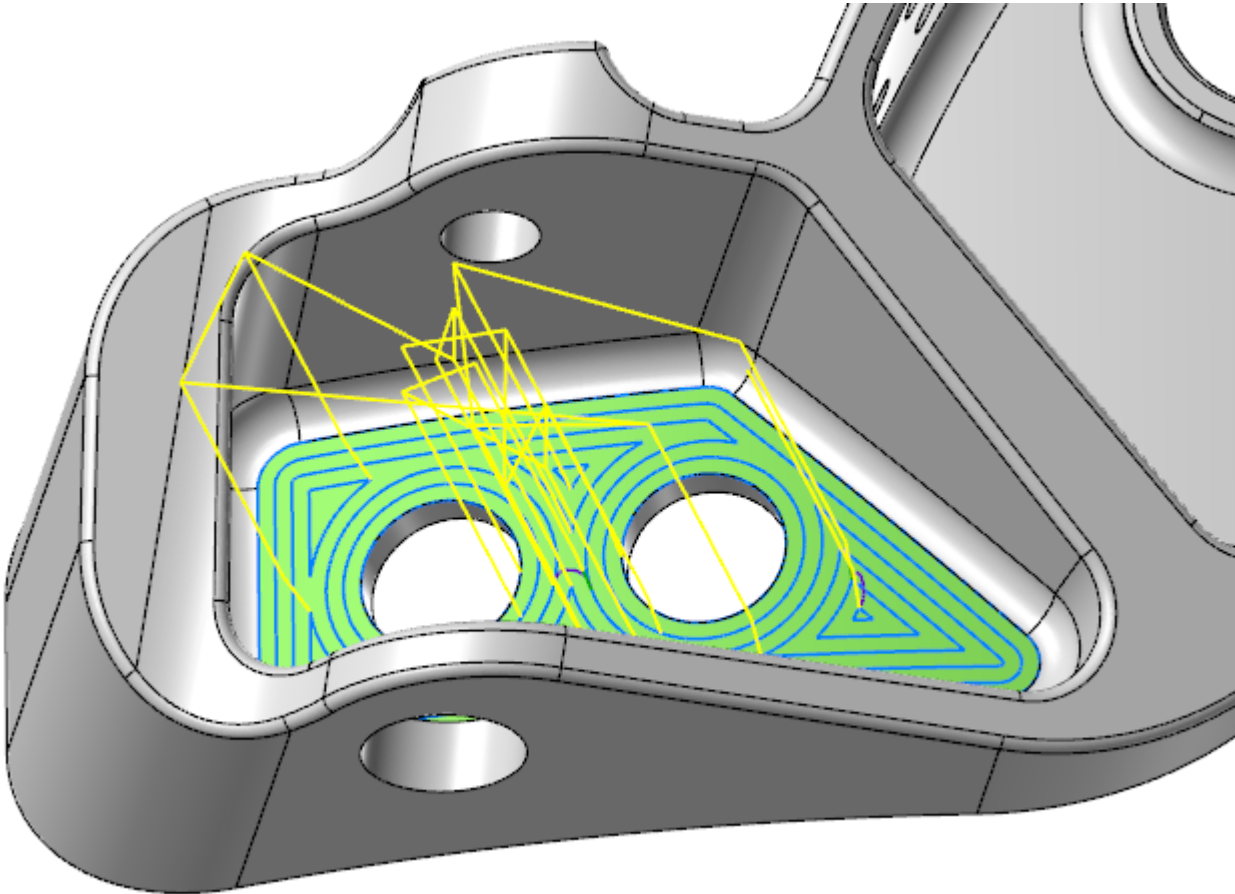

The display of colors for selected geometry is controlled by the **Display graphical elements** button in the dialog box's toolbar. To hide the colors, turn off the **Display graphical elements** button. This button is on by default.

Maximizing Your Tool Engagement

The Dynamic Mill, Face, and Dynamic OptiRough toolpaths now include a new **Maximum engagement** option on the **Cut Parameters** page. When selected, it produces more nominal chips and minimizes the number of small chips. Additionally, Mastercam moves the tool towards the entered **Stepover** as quickly as possible.

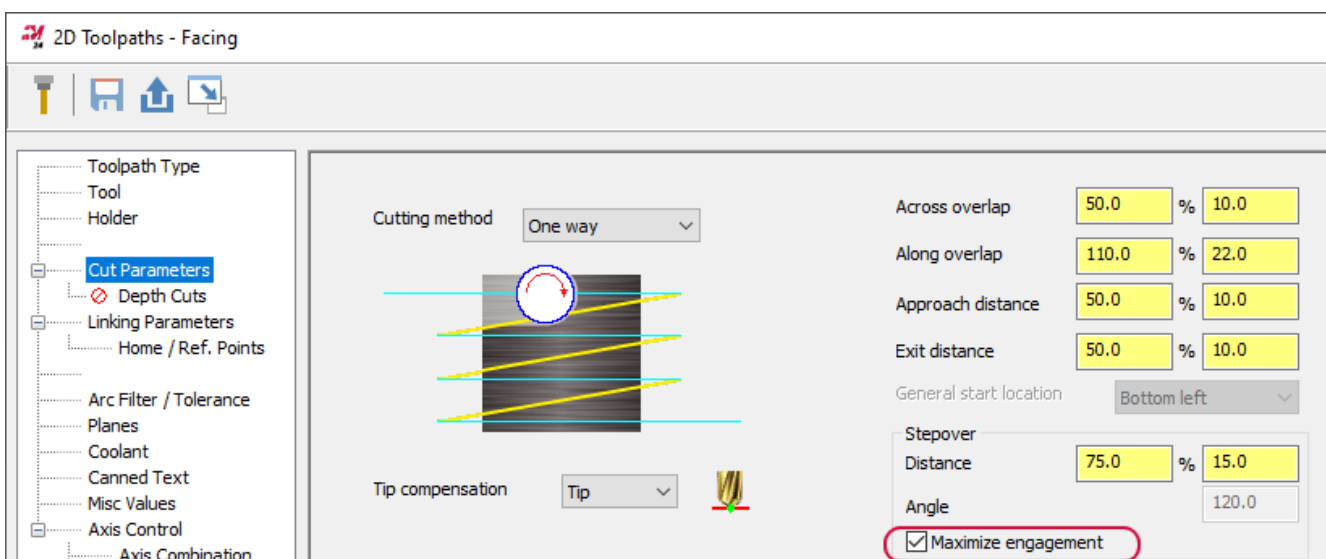

Maximize engagement view:

Disabled

Enabled

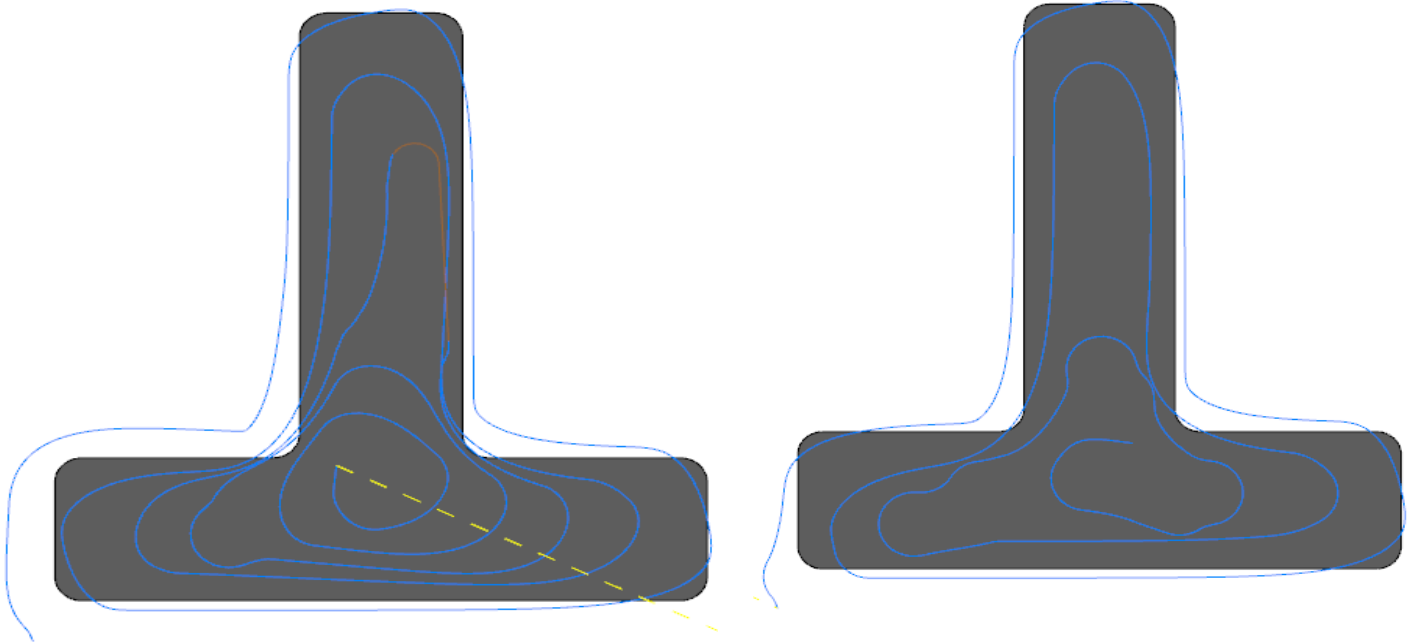

Viewing Your Selection Count for Hole Making and Multiaxis Toolpaths

Options on the Collision Control page for hole making and multiaxis toolpaths now show the number of surfaces selected for avoidance, compensation, and check geometry.

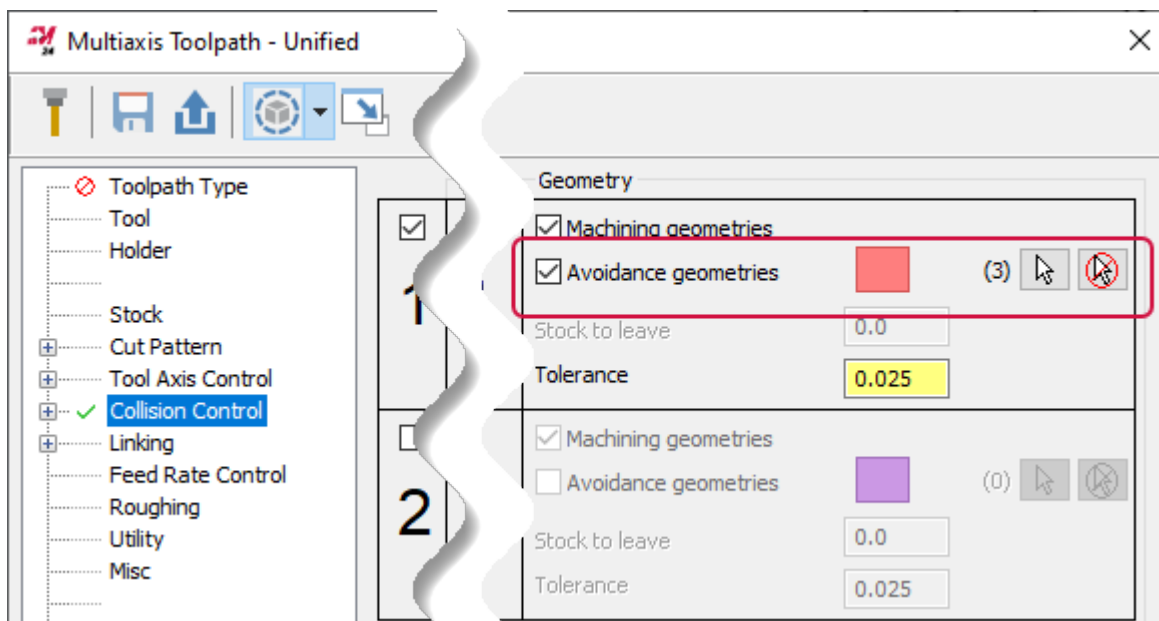

The same type of counter is available in the **Toolpath Hole Definition** panel for hole making toolpaths. This counter shows the number of features selected for holes and is handy when the number of selected features is greater than can fit in the list panel.

Toolpath Hole Definition

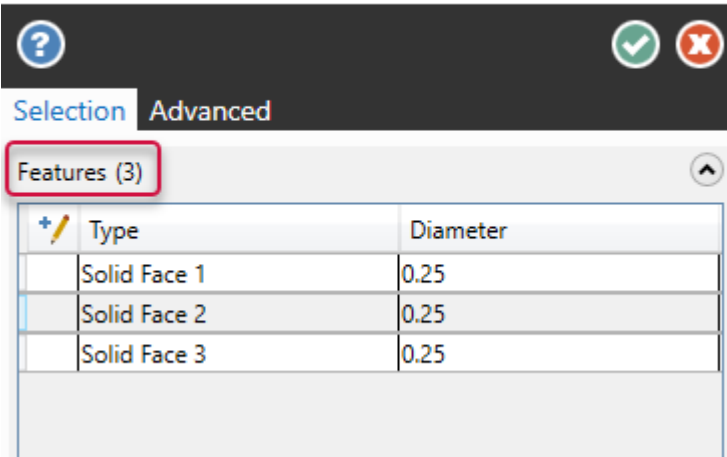

Smoother Milling Toolpath Motion

Milling toolpaths no longer use the Curve chord deviation tolerance found in the Tolerances page of the System Configuration dialog box. Instead, the toolpaths use a new internal tolerance resulting in smoother, more accurate and more consistent motion at times.

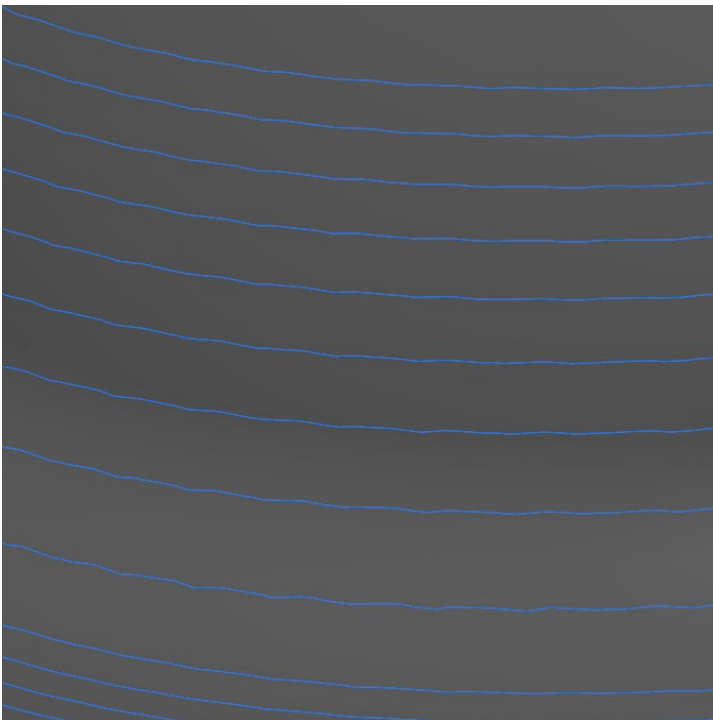
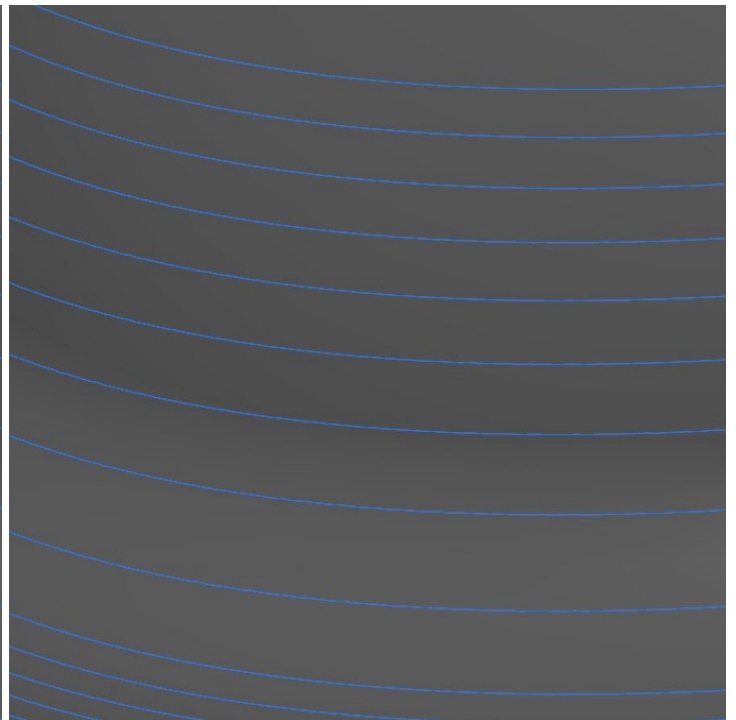
Mastercam 2023**Mastercam 2024**

Including Add-In Functionality to the Swept 2D Toolpath

The Swept 2D toolpath now includes all of the functionality that was previously only available in the Swept 2R Add-in. The Add-In is no longer provided with Mastercam and the functionality is now included in the Swept 2D toolpath.

All Swept 2R cutting methods and rough pass options are now on the Swept 2D Parameters tab. Use the Cutting method drop-down to choose either the Zigzag or One way method and select Rough Passes to enable the roughing pass options.

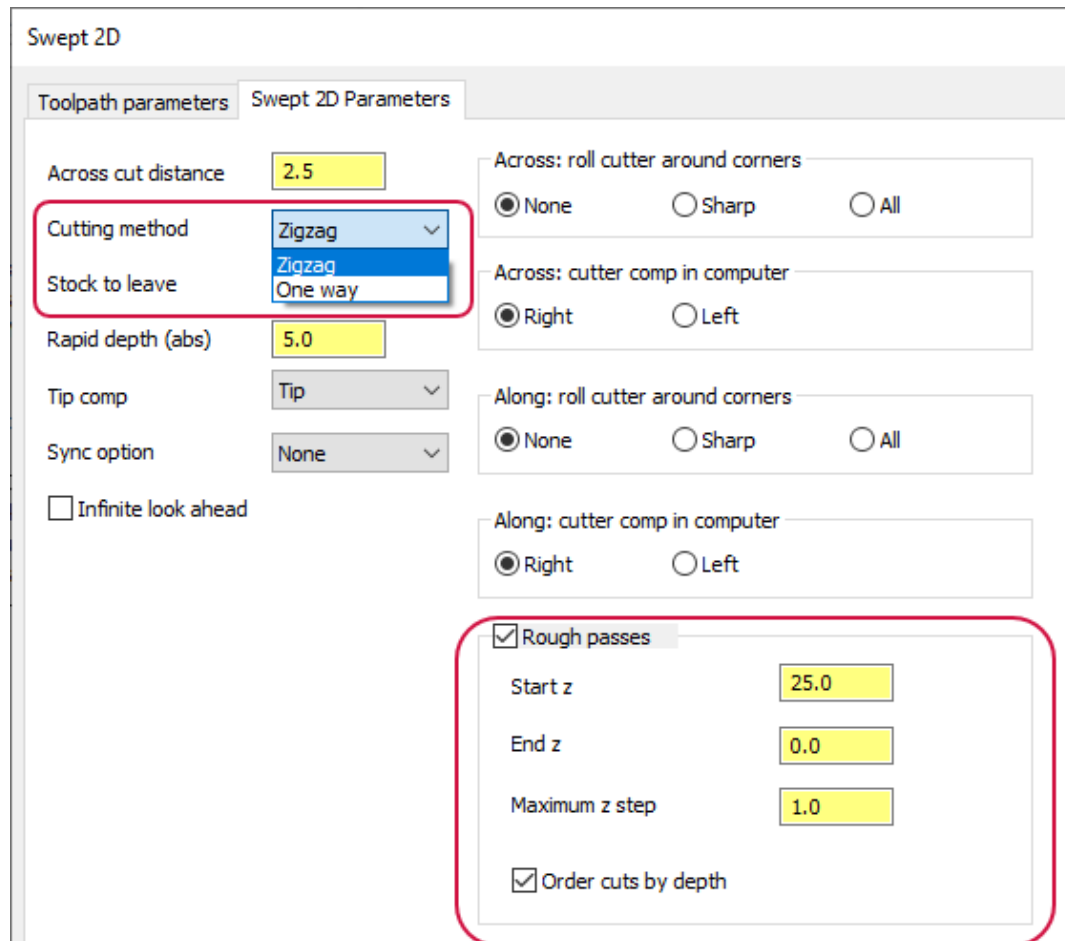

2D Toolpath Enhancements

Listed below are enhancements to 2D milling toolpaths.

Area Mill Enhancements

Listed below are enhancements for 2D Area Mill toolpaths.

Machining with Open and Closed Contour Directions

The Cutting method drop-down on the Cut Parameters page has been replaced with two new drop-downs: **Closed contour direction** and **Open contour direction**. These drop-downs were previously only available to certain 3D high speed toolpaths.

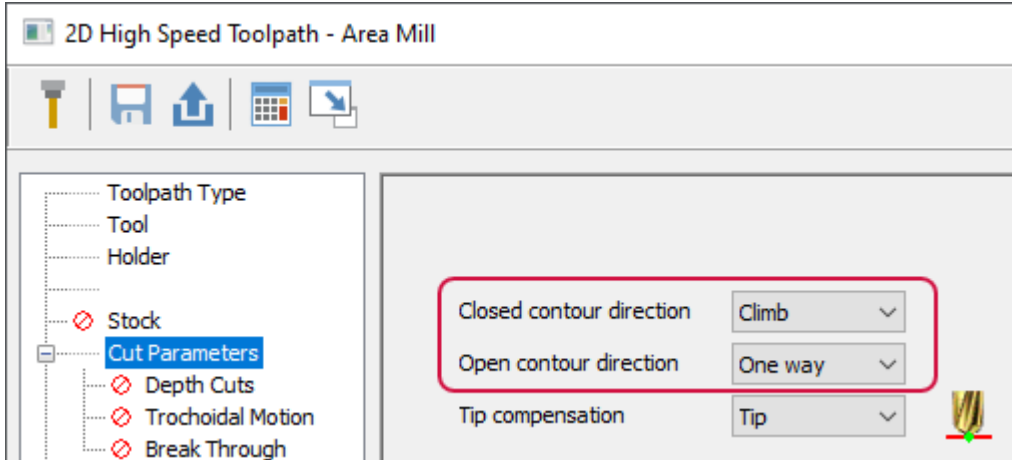

- **Closed contour direction** orients the cutting direction of the closed contours. Closed contours contain continuous motion without a need for a retract move or reversal of direction. Choose between **Climb** or **Conventional**.
- **Open contour direction** orients the cutting direction of open contours. Choose between **One Way** or **Zigzag**.

Setting Lead Motion

The HST Leads page for Area Mill toolpaths now includes four new options: **Horizontal arc entry**, **Horizontal arc exit**, **Ramp angle**, and **Sweep angle**. Previously, you could only change the **Vertical arc entry** and **Vertical arc exit**. These parameters specify the entry and exit radius values. The arc is created vertically and horizontally to lead on and off the material.

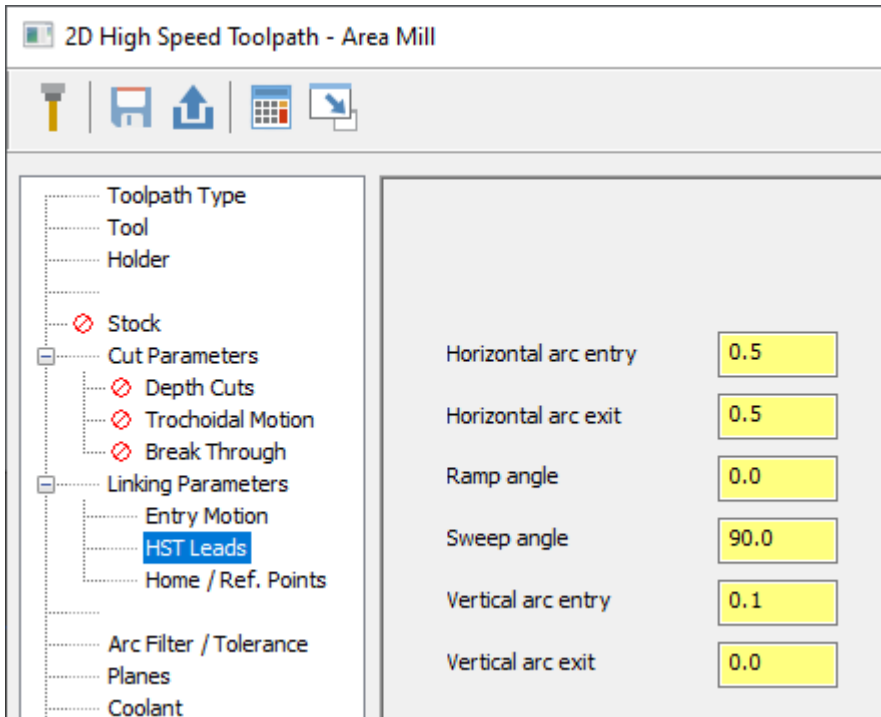

- **Horizontal arc entry/exit:** Sets the horizontal arc size as the tool approaches the cutting depth or comes off the part.
- **Sweep angle:** Sets the sweep of the horizontal arc between 0 and 180 degrees.
- **Ramp angle:** When you enter a value other than 0 for the **Horizontal arc entry**, the entry move becomes a small helix when moving into a new region. This parameter sets the angle of the arc into the helix move.
- **Vertical arc entry/exit:** Sets the vertical arc size as the tool approaches the cutting depth or comes off the part.

Outputting Feed Moves and Fitting Arc Moves

Model Chamfer and Dynamic Contour toolpaths now include the **Arc fit maximum radius** and **Output feed move** options on the **Linking Parameters** page. Previously, this option was available to other 2D toolpaths.

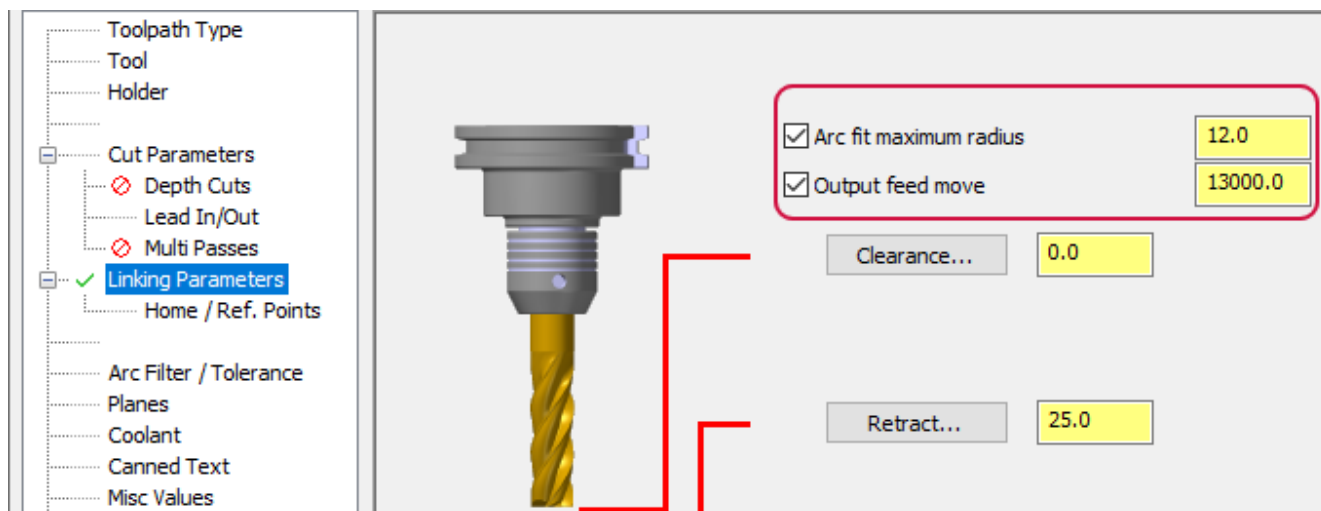

Arc fit maximum radius attempts to fit 90-degree arc moves into rapid and clearance moves. If the entered radius does not fit, then the output creates a 180-degree arc.

Output feed move outputs all rapid moves between passes as a feed rate move instead of a rapid move. This is helpful when the tool needs to make irregular moves per pass to jump between different areas of the part.

Overriding Your Feed Rate When Cutting Around Corners

The following toolpaths now include the **Override Arc Feed Rate** option on the **Arc/Filter Tolerances** page.

- Dynamic Contour
- Peel Mill
- Model Chamfer

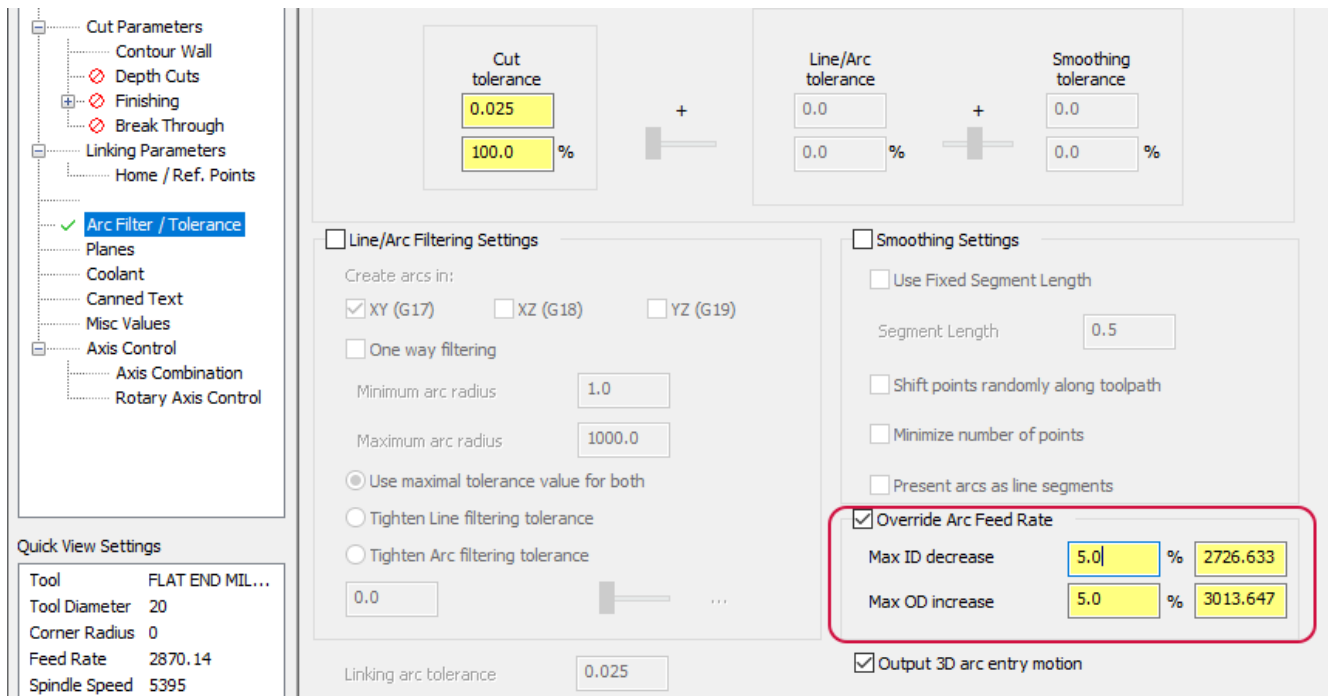

Override Arc Feed Rate increases and decreases the arc feed rate when cutting around corners. The base feed rate is set on the Tool page.

Max ID decrease sets the maximum feed rate decrease for movement around inside arcs as a percentage or an exact feed rate. **Max OD increase** sets the maximum feed rate increase for movement around outside arcs as a percentage or an exact feed rate.

Reducing Tool Wear When Using Roll In

You can now set a **Clearance** option when using **Roll in** for 2D Face toolpaths. Previously, this value was hard-coded and always set to 10%. **Clearance** controls the connecting move between the roll in arc and the toolpath motion. By having more control over the roll in motion, you have the ability to reduce tool wear when cutting into hard materials.

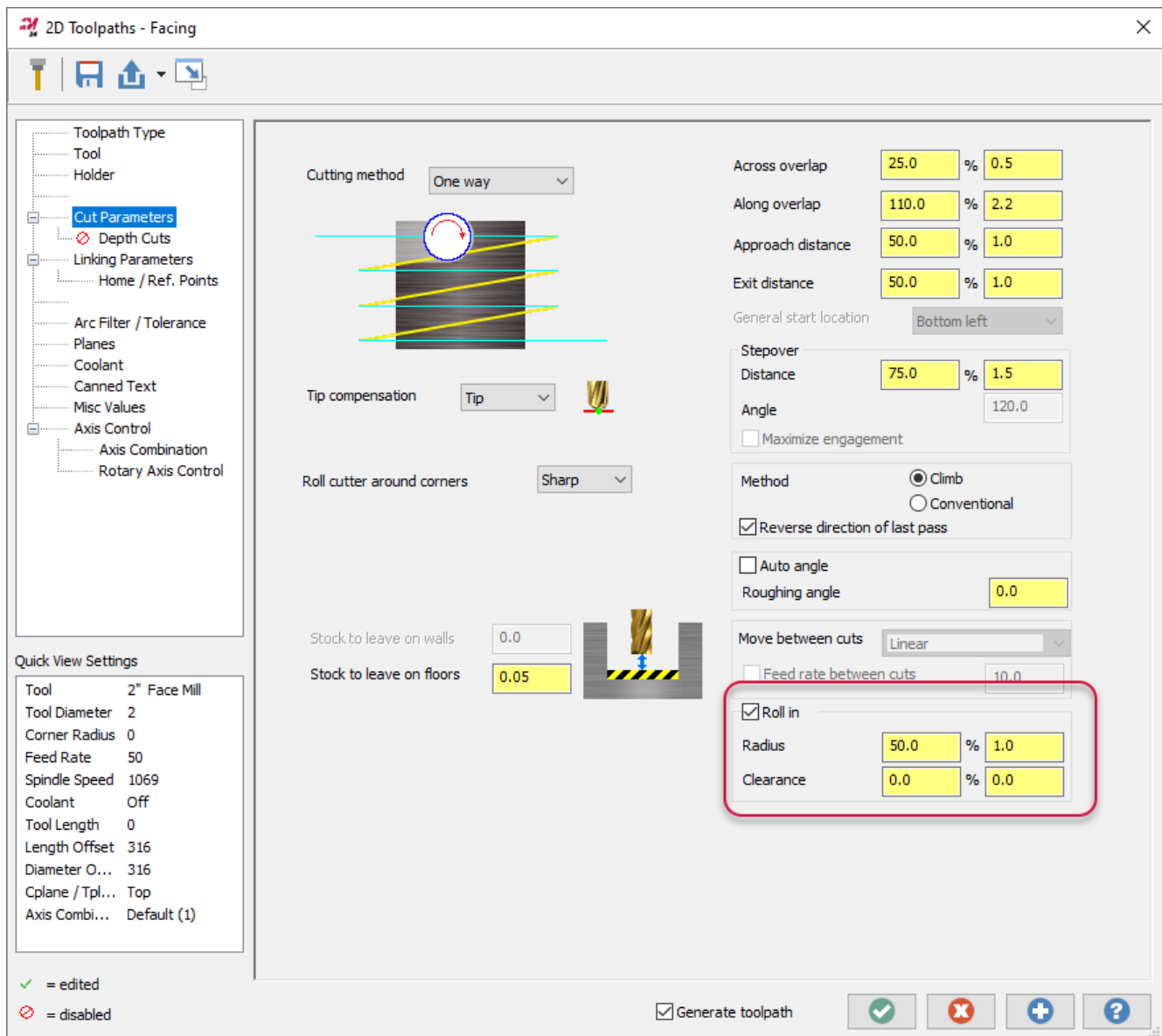

Creating Smooth Tool Motion in Sharp Corners for Contour Remachining

When creating a Contour Remachining toolpath, the Internal corner rounding radius is now available. In previous versions, this option was disabled. Internal corner rounding radius creates smoother tool motion in sharp corners. Corner smoothing reduces tool wear and creates efficient tool motion.

Hole Making Toolpath Enhancements

Listed below are enhancements to hole making toolpaths.

Process Hole

Process Hole is a toolpath allowing users to apply a "Process," consisting of one or more individual holemaking operations to solid hole features on a part model in Mill or Router toolpaths. Processes are built in Operations Libraries. These libraries are simply separate Mastercam files within which each toolpath group is considered a Process. Applicable processes can be selected and imported into the working file by the user by creating a Process Hole operation.

Tool type and number, feeds and speeds, and operation order are all controlled by the Operations Library, while geometry selection and linking parameters are determined within the Process Hole operation. Both 3 and 5 axis scenarios are valid for Process Hole geometry selection. Process operations can be individually edited to adjust parameters in the local file without affecting the Operations Library. After creating a Process Hole operation, you can right-click in the **Toolpaths Manager**, the **Process Hole** panel and **Explode hole operation** into its component operations and work with them like any other toolpath.

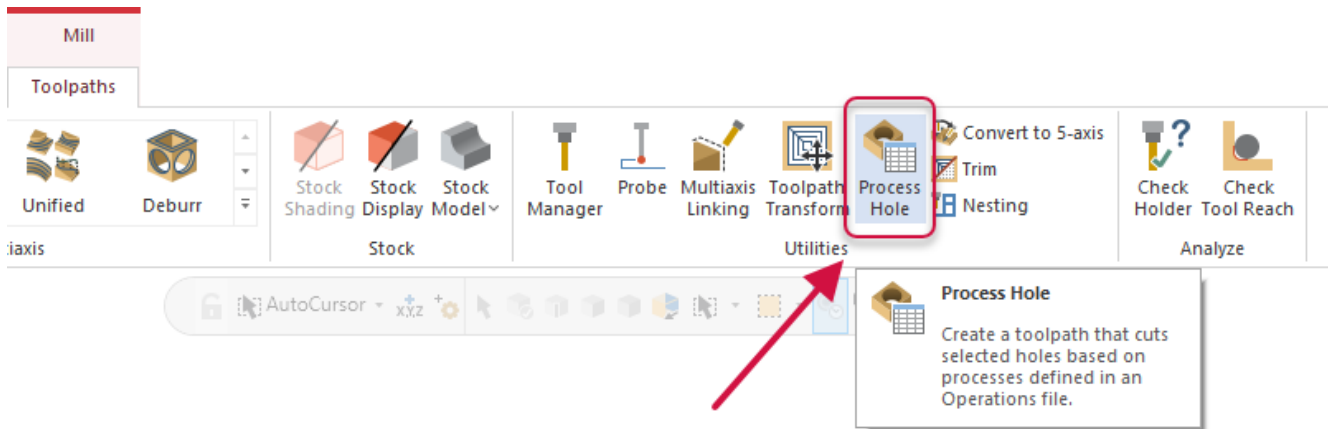

Consolidating Parameter Locations

In previous versions of Mastercam, **Tip Compensation** and **Break Through Amount** were on subpages below the **Linking Parameters** and **Cut Parameters** pages, respectively. To check your tip compensation or break through, you had to switch to these subpages. Mastercam 2024 moves these parameters to the main **Linking Parameters** page, eliminating the need to switch between pages.

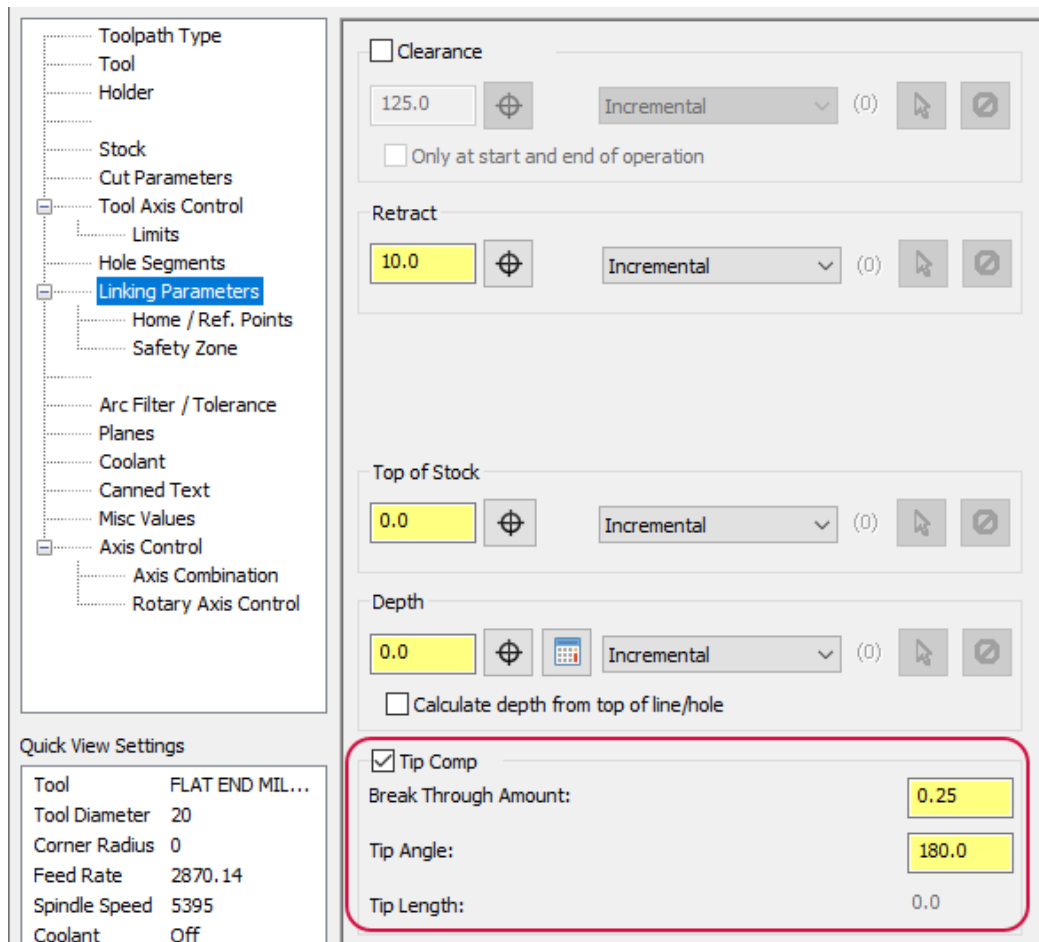

3D Toolpath Enhancements

Listed below are enhancements to 3D milling toolpaths.

Controlling Your Cut Order for Raster Toolpaths

3D High Speed Raster toolpaths include a new Cut order drop-down on the Cut Parameters page to further customize your toolpath. Cut order sets how the toolpath machines your part, either by Lanes or Clusters.

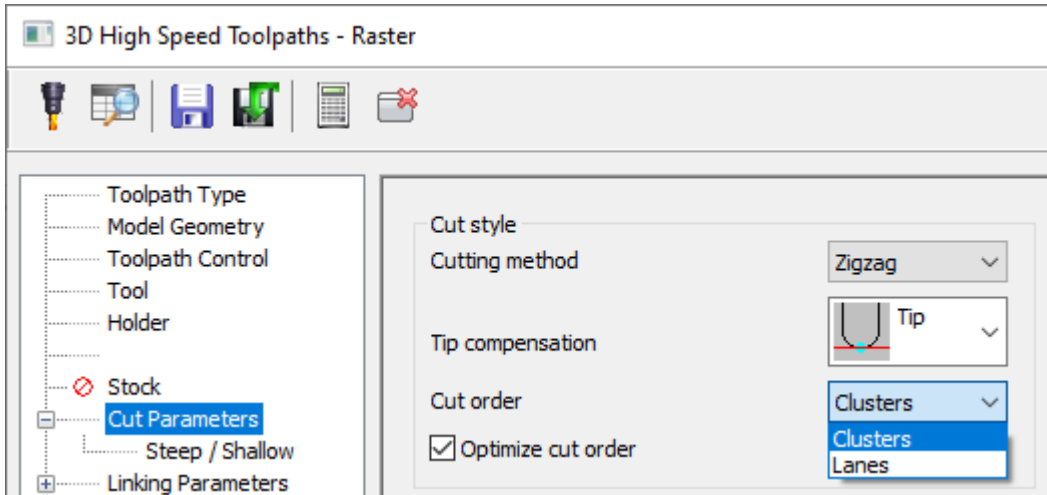

Lanes cut the part in one direction. Clusters finish a section before moving to the next.

Setting First/Last Leads for 3D High Speed Finishing Toolpaths

3D High Speed Finishing toolpaths, except for Horizontal Area, now include the new First/Last Leads page. This new page provides more granular control over the first and last moves of the toolpath.

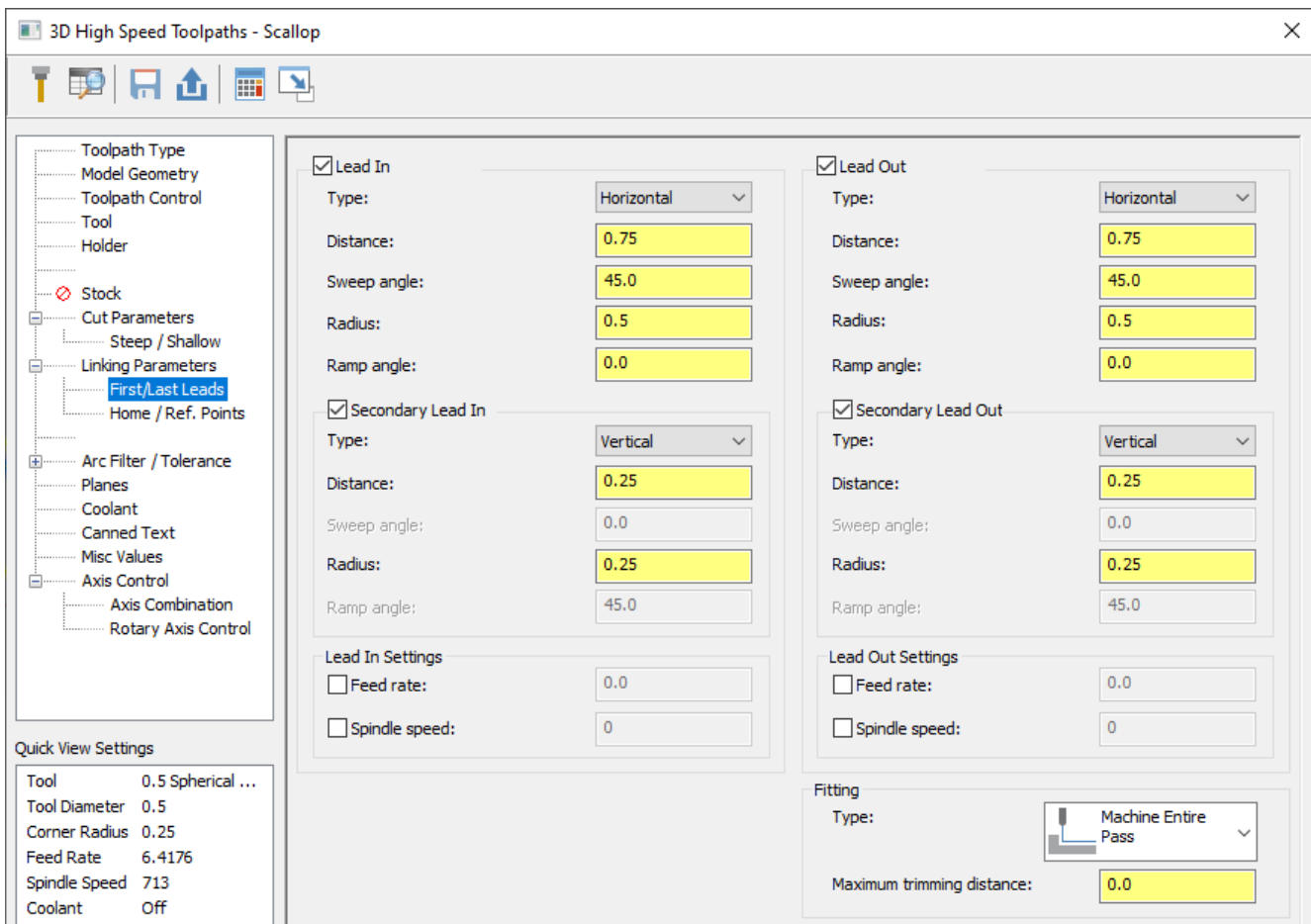

Machining Flat Areas with Area Roughing

Mastercam 2022 introduced **Critical Depths** to Area Roughing, which customizes how Mastercam handles flat areas when machining. In Mastercam 2024, this functionality has been expanded to the Area Roughing toolpath.

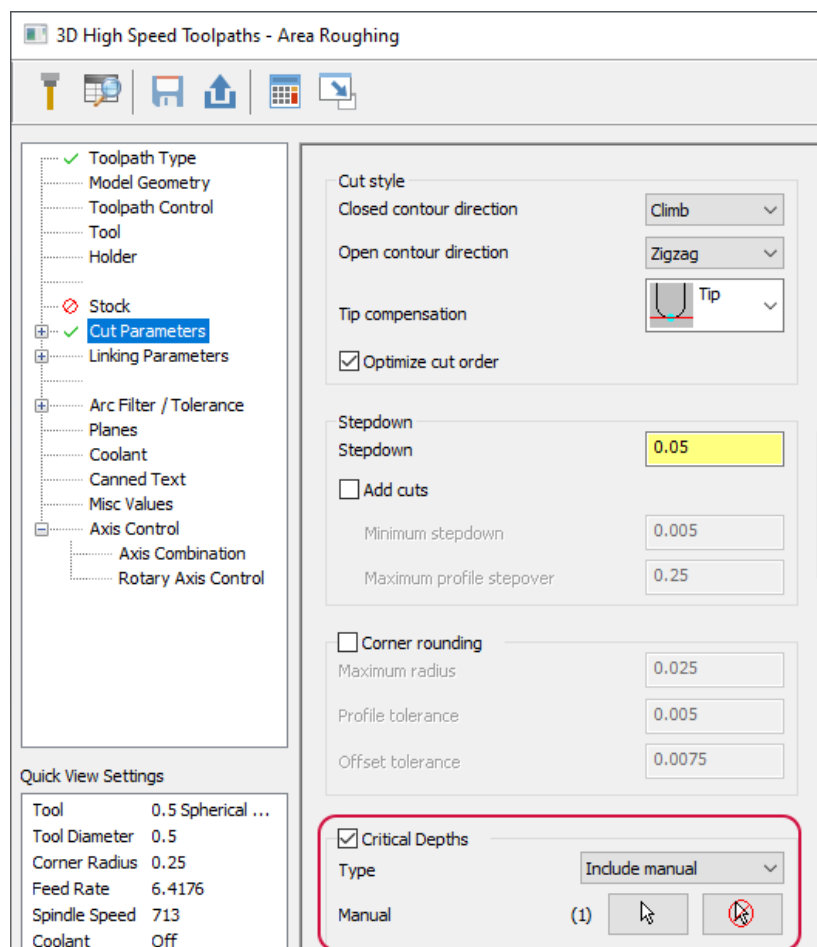

The type of flat area to be machined by a single Area Roughing contour. Choose the **Type** dropdown:

- **Include flats:** Includes flat areas when machining.
- **Include manual:** Includes manually selected flat areas when machining. Use the **Select** button to choose the flats.

Setting the Minimum Clearance Distance when Retracting

The **Part clearance** option is now available when **Type** is set to **Full vertical retract** for 3D high speed toolpaths. **Part clearance** sets the minimum distance the tool maintains above the part while it is rapiding between passes.

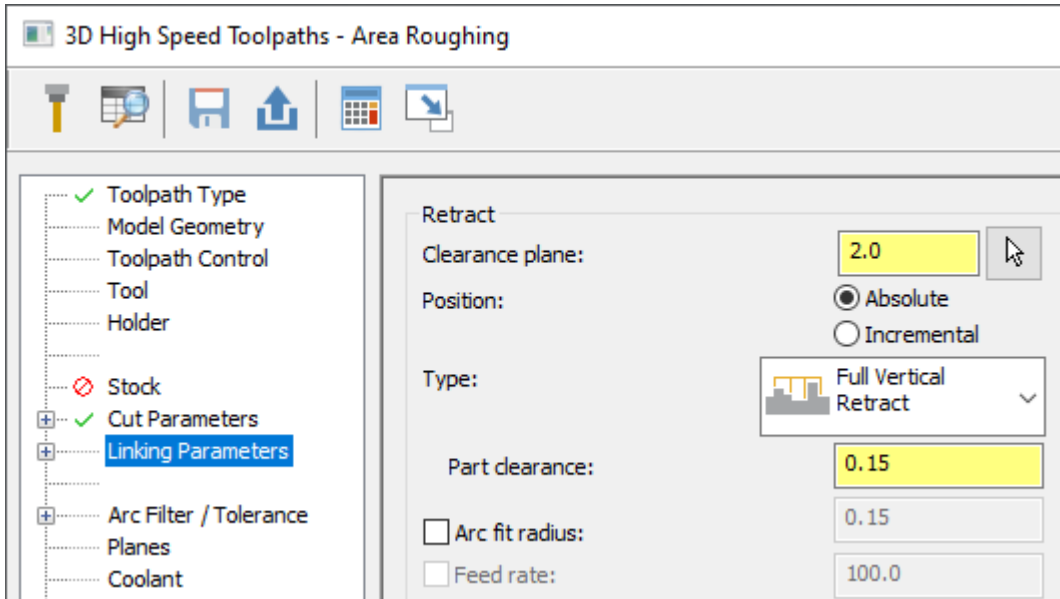

The actual retract height is set by the **Clearance plane**. However, if the retract height is less than the **Part clearance**, Mastercam adds an additional linear move between them until the total height equals the **Part clearance**.

Dynamic OptiRough Improvements

The Dynamic OptiRough toolpath now uses more efficient helix start heights and retract heights. This is especially helpful when there are various Z depth heights.

Using the Same Wall and Floor Stock Values for 3D Toolpaths

The new **Same wall and floor stock** option on the **Model Geometry** page now sets both the **Wall Stock** and **Floor Stock** columns to the same value. Each geometry selection grid has a corresponding option.

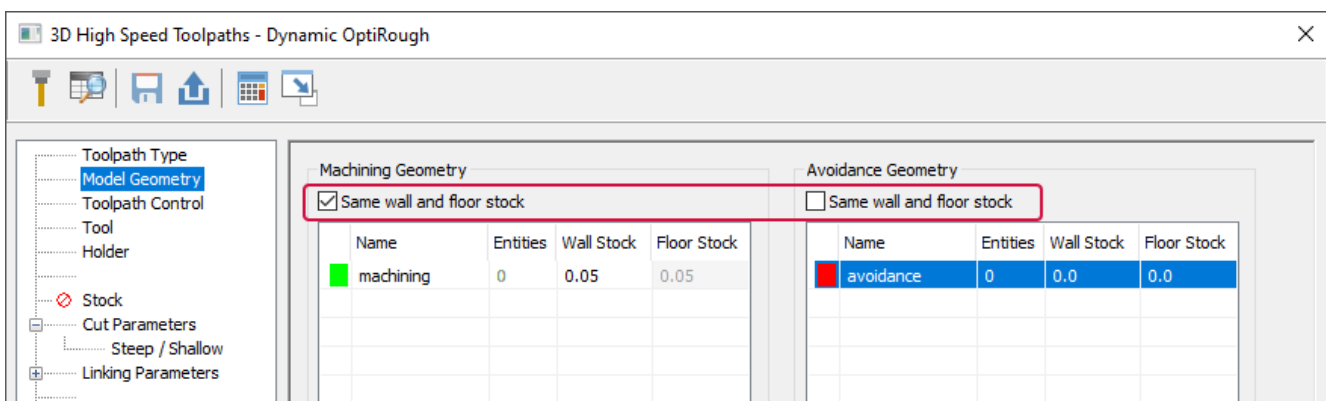

When selected for a specific grid, the **Wall Stock** amount is copied to the corresponding **Floor Stock** and the **Floor Stock** column is locked. This new option helps when you want to keep both values the same, making it easier to edit the stock values, especially if you have more than one set of geometry groups.

Reversing the Cut Order

The **Expand inside to outside** parameter has been renamed to **Reverse cut order** to better explain the functionality. The parameter has been renamed for the following toolpaths:

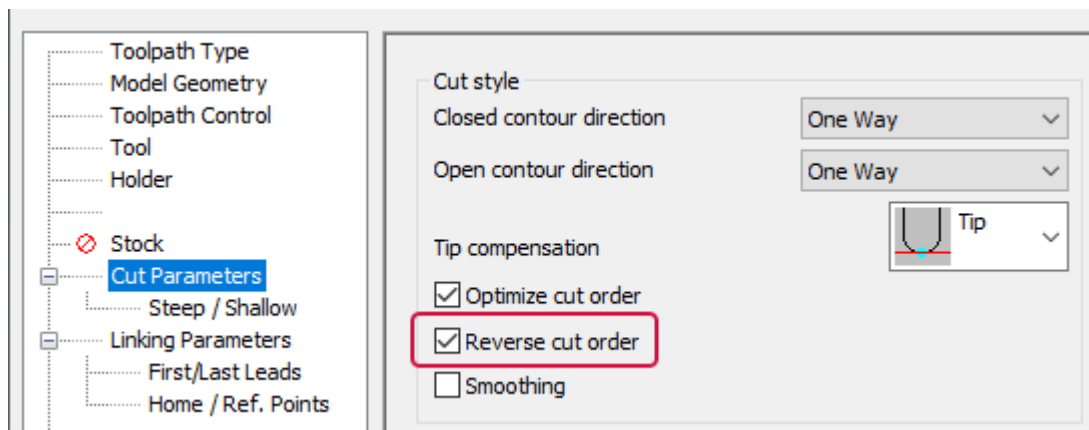

- Equal Scallop
- 3D Scallop
- Surface Finish Scallop
- Surface Finish Leftover
- Surface Finish Shallow

Reverse cut order starts the toolpath in the center of the part and cuts towards the outside. When you have **Reverse cut order** and **Curves** selected for Equal Scallop or 3D Scallop, the toolpath is instead created toward the curves. If **Reverse cut order** is deselected, the toolpaths behave normally and are created outward using the curves as a starting point.

Detecting Undercut Stock When Machining

Waterline toolpaths are now aware of undercut stock conditions resulting in improvement to the toolpath motion, including less air cutting. This awareness was previously introduced for Dynamic OptiRough and Area Roughing in Mastercam 2023. This option has also been renamed from **Detect undercut stock** to **Detect stock break through**.

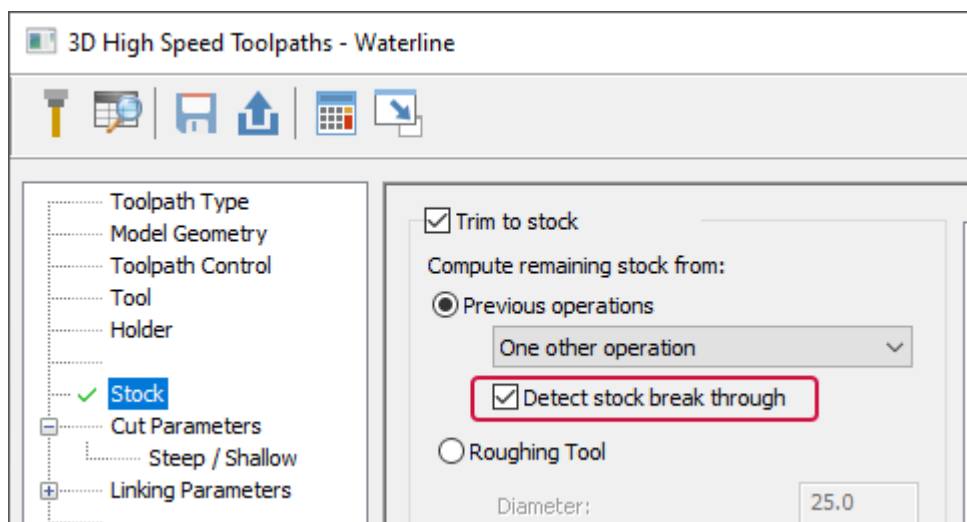

Use the **Detect stock break through** option to eliminate air cuts where no stock is below the previous pass. This option is only available when **Previous operations** is set to **One other operation** and the operation is a stock model.

Removing Excess Material with Blend Toolpaths

Blend toolpaths, when **Cutting method** is set to **Spiral**, now machine a full pass at the start and end of the spiral. This helps eliminate small amounts of stock that may be left behind after machining.

Controlling Tool Motion in Shallow Part Areas

The 3D high speed Waterline toolpath now includes the **Allow partial cuts** option. **Allow partial cuts** adds or removes tool motion only from the shallow areas of the part. This option also does not create closed cuts at a constant Z level around the part. This option is on the **Cut Parameters** page.

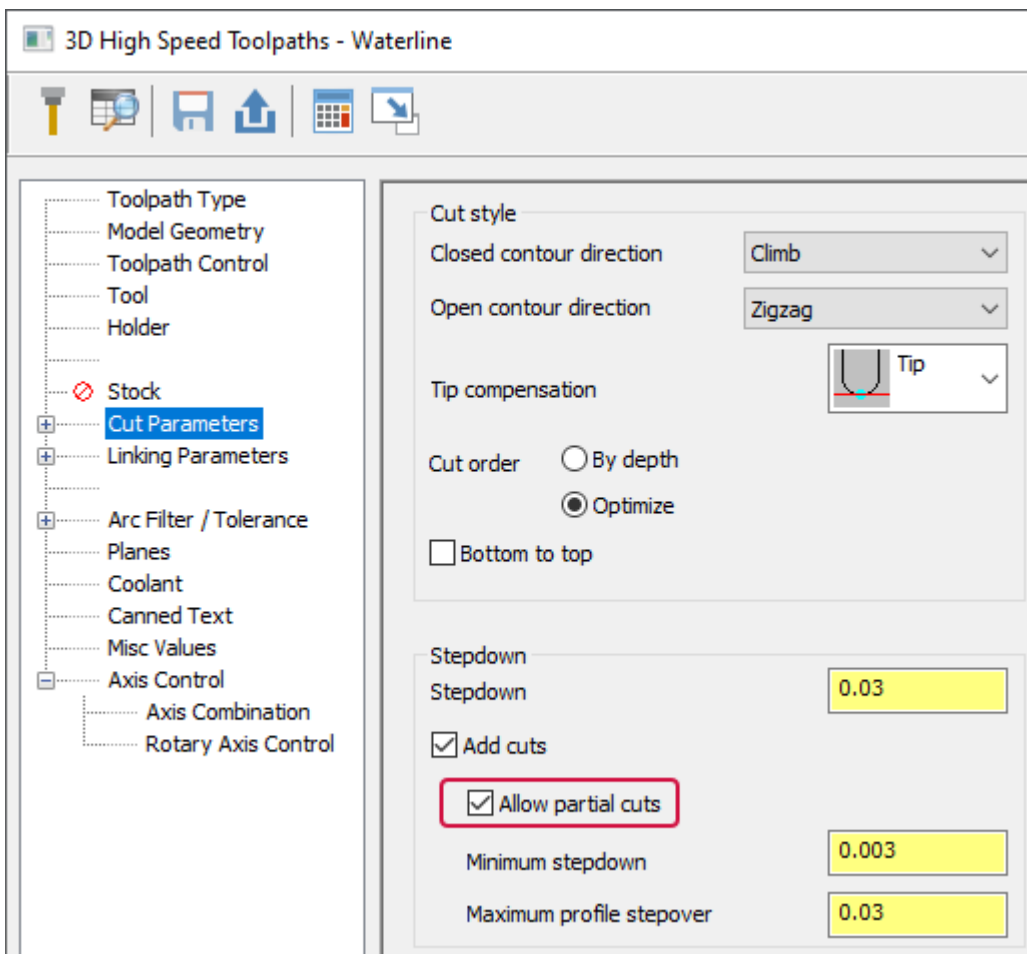

Selecting Regions to Avoid for Pencil Toolpaths

You can now select avoidance geometry for 3D high speed Pencil toolpaths. In previous releases, the Avoidance Geometry selection grid was disabled.

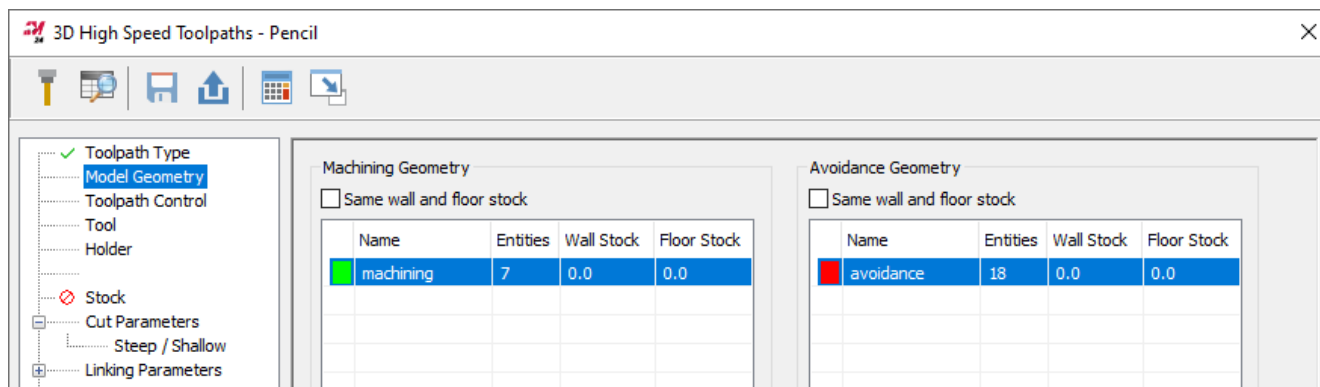

Multiaxis Toolpath Enhancements

Listed below are enhancements to multiaxis toolpaths.

Pocketing and Roughing for 3-Axis

Mastercam 2024 features a new tool axis control method for Pocketing/Roughing that can lock a Pocketing path to a specific tool orientation. You can create gouge-free toolpaths for 3-axis machines or create simplified Multiaxis roughing paths on certain geometry.

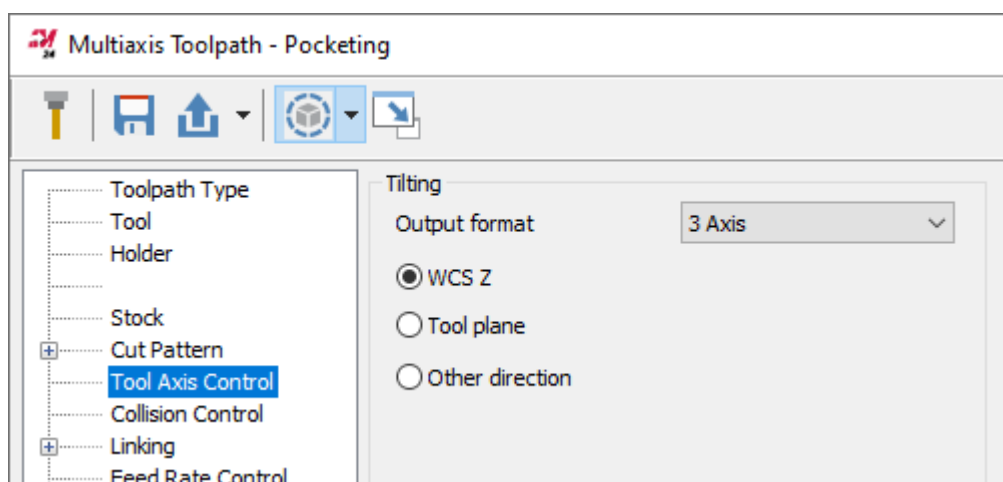

Pocketing for Automatic Tool Axis Control

Pocketing's new automatic tool axis control generates the tool posture for a floor or wall finishing toolpath. This feature enables the toolpath to automatically determine the proper contact point and cutting posture depending on the tool type you choose. This option reduces programming time by simplifying tool axis definition.

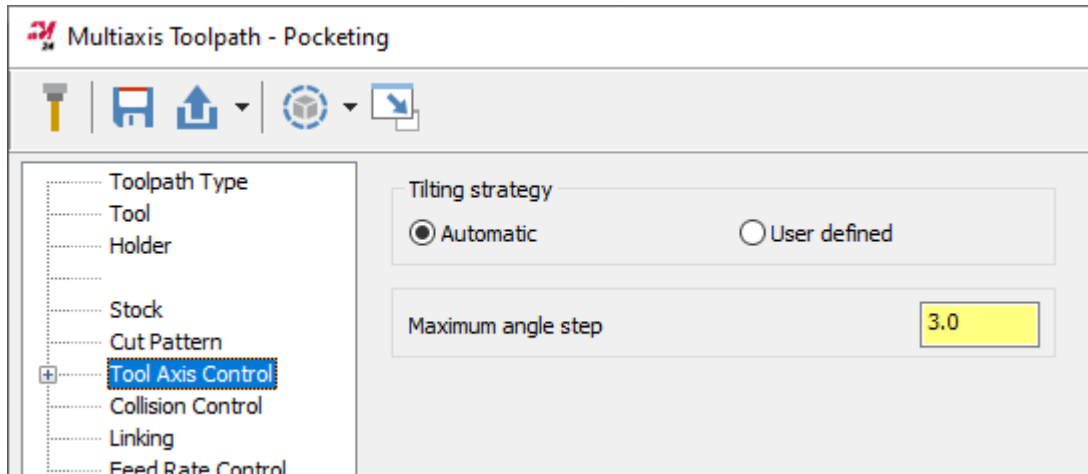

Collision Checking for Blade Expert

The Blade Expert toolpath allows a user to generate a collision-free path even with large holders or tight tolerances. The toolpath specifies a more comprehensive collision check than previous versions of Mastercam. This toolpath now includes checking the tool and holder against all blade geometry. This option increases calculation time, but is useful for situations with reduced clearance or large holders.

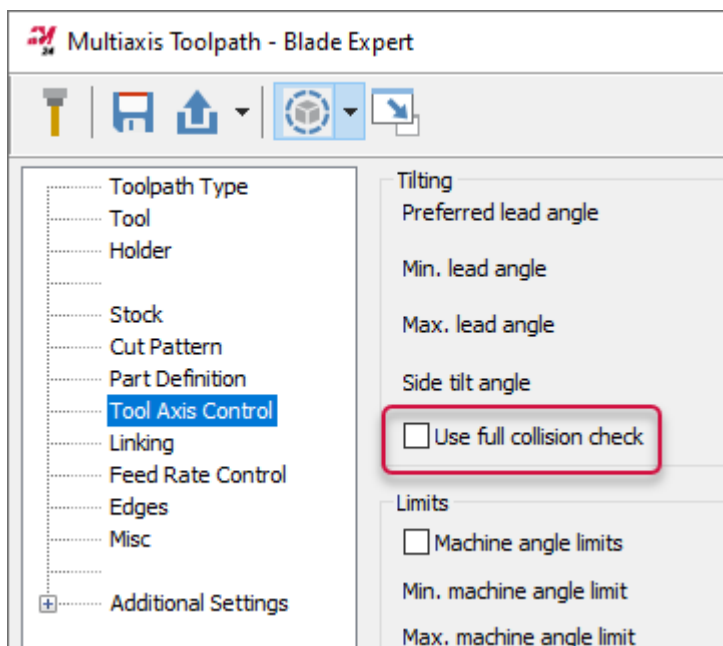

Deburr Enhancements

Listed below are enhancements made to the multiaxis Deburr toolpath.

Specifying the Cut Type

Mastercam 2023 introduced the ability to cut with the flank of the tool. This option was presented as a checkbox and a value field that controlled a contact percentage along the flute on the Toolpath Control page.

For Mastercam 2024, those controls are consolidated into a drop-down menu where you choose whether to cut with the tip or the flank of the tool. If you choose to cut with the flank or taper, the percentage option appears. With that option, you can specify the contact percentage along the flute.

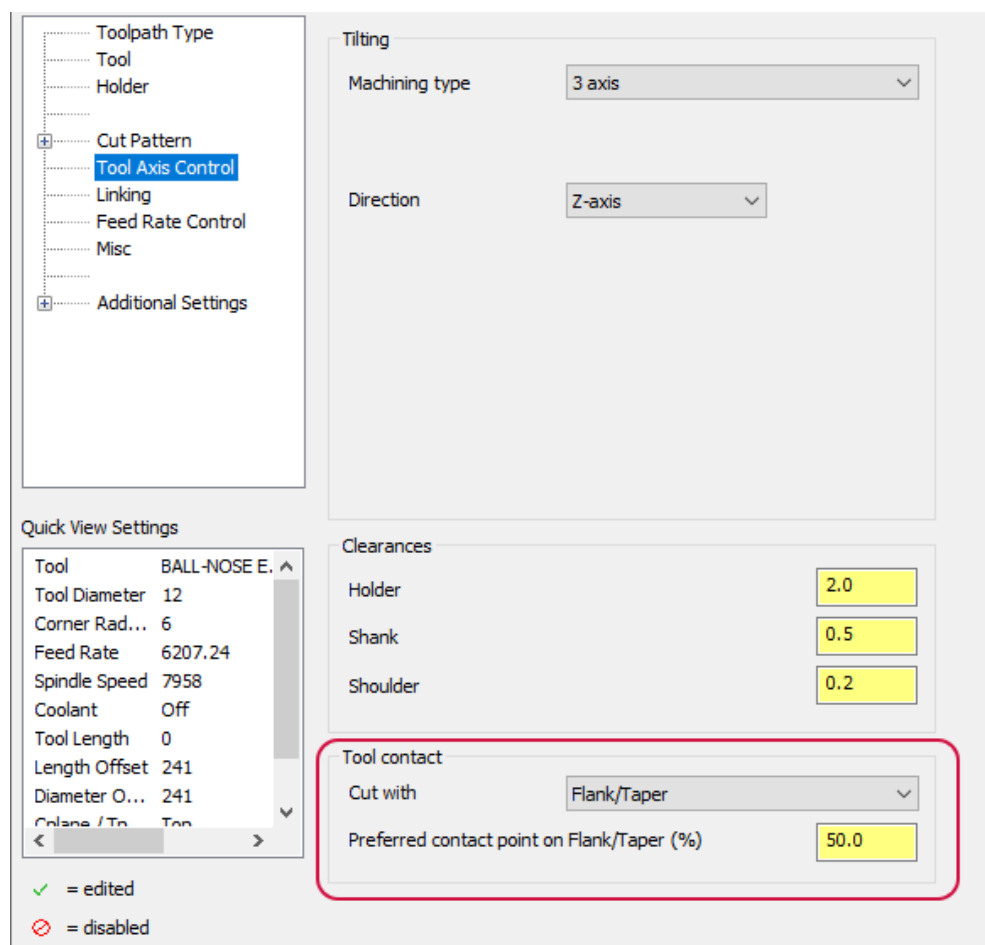

Avoiding Contact Point on Tip

A new Deburr option, **Avoid contact point on tip**, angles the tool to avoid cutting with the tool's center tip. To see this option, **Machining type** must be set to **5 axis (simultaneous)** and **Cut with** must be set to **Tip**.

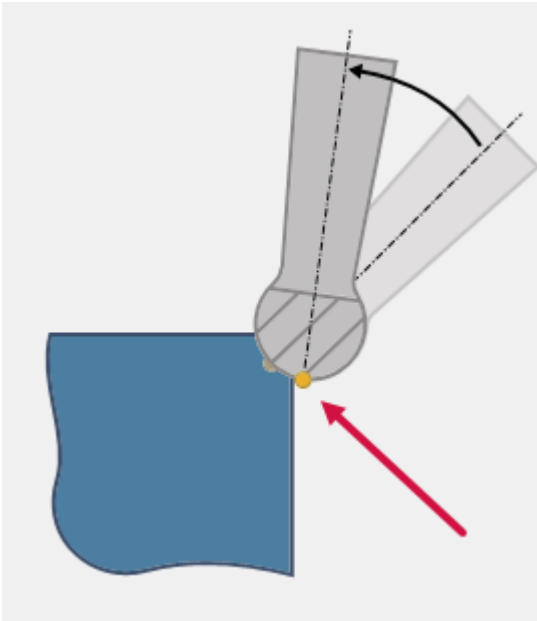

Use this option to prevent the possibility of additional burrs when cutting, such burrs can occur because of the zero SFM at the tip of the tool. You can find **Avoid contact point on tip** in the **Tool Axis Control** page for Deburr toolpaths.

The screenshot shows the 'Tool Axis Control' settings for a Deburr toolpath. The 'Tool Axis Control' option is selected in the left-hand menu. The settings are as follows:

- Tilting:**
 - Machining type: 5 axis (simultaneous)
 - Strategy: Normal to contour
 - Tilt range
 - Lead angle to cutting direction: 0.0
 - Maximum angle step: 3.0
- Clearances:**
 - Holder: 2.0
 - Shank: 0.5
 - Shoulder: 0.2
- Tool contact:**
 - Cut with: Tip
 - Avoid contact point on tip

Quick View Settings:

Tool	BALL-NOSE E.
Tool Diameter	12
Corner Rad...	6
Feed Rate	6207.24
Spindle Speed	7958
Coolant	Off
Tool Length	0
Length Offset	241
Diameter O...	241
Plane / To...	Top

✓ = edited

New Supported Tool Types

The Deburr toolpath now supports the following tool types.

For Tip:

- Ball end mill
- Lollipop mill (supports undercutting)

For Flank/Taper:

- Bull end mill (supports cutting with flutes, but not the bull radius)
- Corner chamfer end mill (supports cutting with flutes, but not the corner chamfer)
- Taper mill
- Dove mill (supports undercutting)
- Chamfer mill

Load Save Defaults

For Mastercam 2024, we've made some changes on how loading and saving Defaults works from tree-style toolpath dialogs. Click a toolpath's **Save toolpath parameters to a file** or **Load toolpath parameters from file** button, and Mastercam displays the panel shown in the following image. (There are **Save Toolpath Settings** and **Load Toolpath Settings** versions of the panel.)

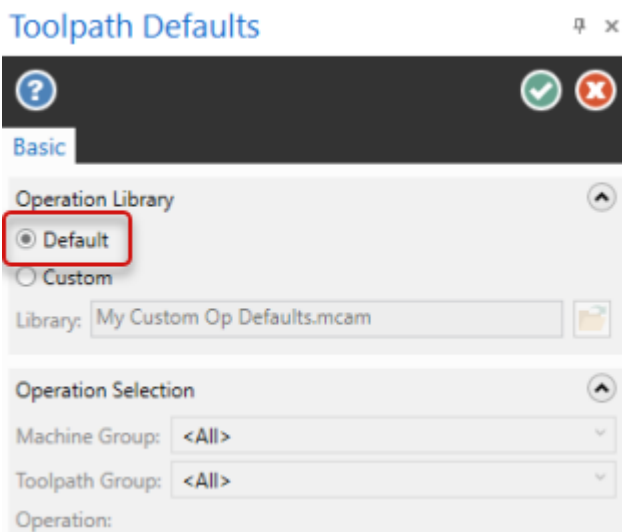

To load defaults for the current operation, leave **Default** selected, and click **OK**. Mastercam loads the defaults from the **.mcam-defaults** file specified in the **Library** path.

Select **Custom** to enable the **Select Operation Library** button, which, when clicked, displays the **Select Operation Library File** dialog box. Use this dialog box to choose any Mastercam file from which to load operation parameters.

From the selected operations file, Mastercam populates the **Operation** table with all operations appropriate for your current operation (see the following image) and from which you can load your defaults. Mastercam uses the operation's name for the operation's comment and the ID for the toolpath ID number. In the **Operation** table, click the toolpath to load, and then click **OK** to load defaults.

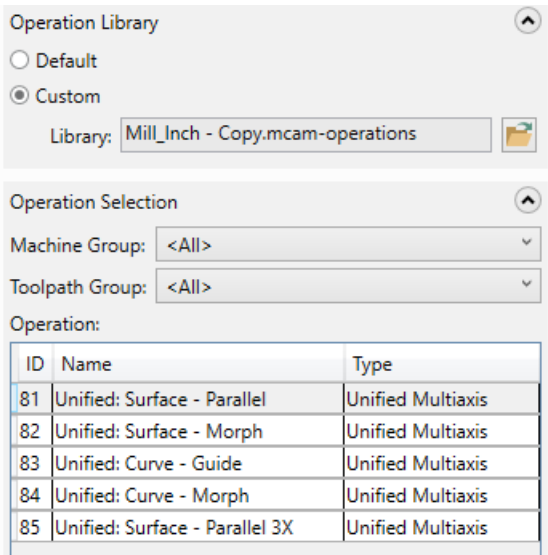

In the toolpath parameters dialog box, click the triangle next to the **Load toolpath parameters from file** button to see a drop-down list of operations in the currently selected library. You can select from this list without having to enter the **Load Toolpath Settings** panel and so speed up your workflow.

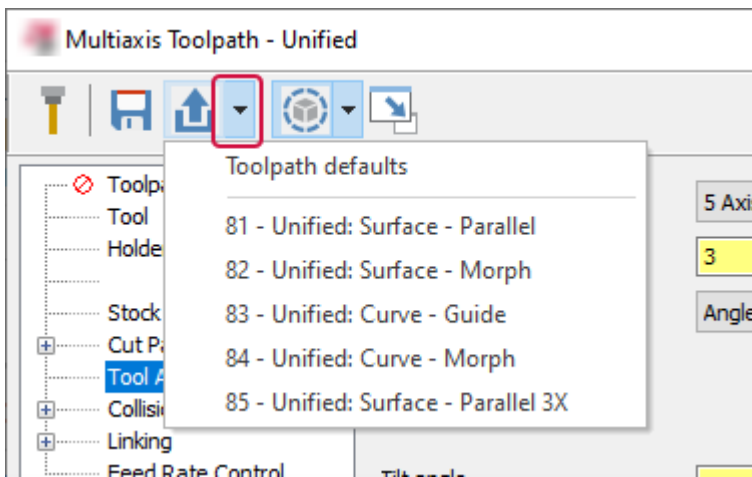

Machining Angle Controls

Listed below are enhancements made to the **Multiaxis Unified Plane** toolpath.

For Mastercam 2024, the Machining Angles controls are now available on the majority of plane cut pattern options. The angles offered for adjustment correspond to the plane style choice.

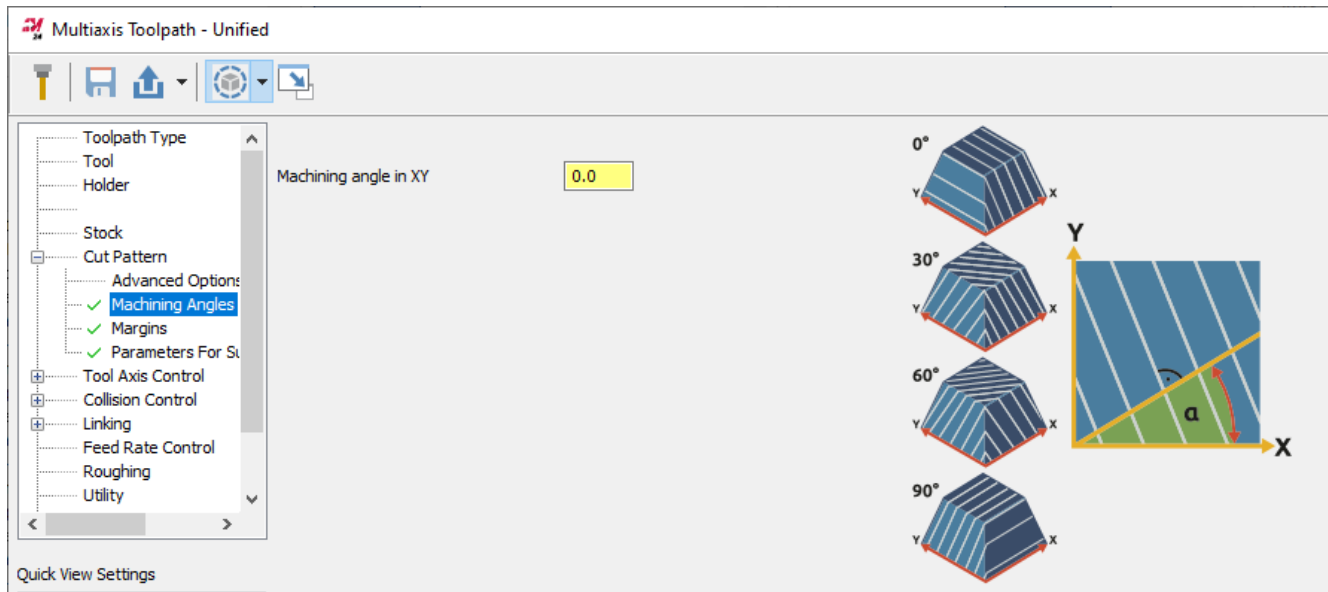

New Machine Angle Controls Supported Plane Types

- WCS Z
- WCS XY
- Construction Plane Z
- Construction Plane XY
- Tool Plane Z
- Tool Plane XY
- Custom Angles

Straighten cuts on boundaries

Enabling **Straighten cuts on boundaries** avoids rolling effects when the machining surface is wider than the drive curve or when cuts are in the shadow of a hole or the construction of the machining surface. The setting mimics the **Extend edge curve** option available for other cut types and reduces wrinkling or rippling to produce a more uniform pattern across the extents of the selected geometry.

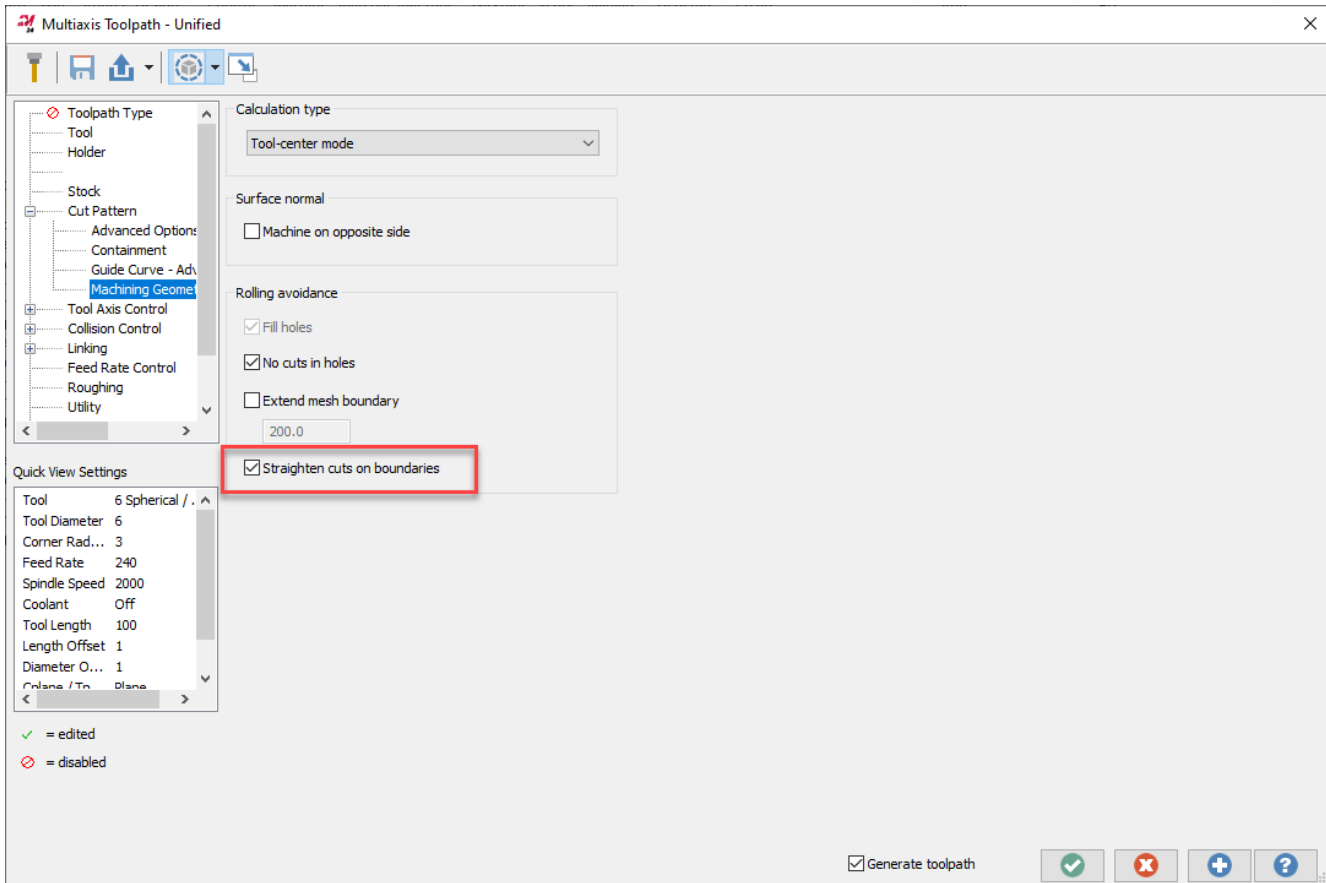

Turning Enhancements

Listed below are major enhancements to the Lathe and Mill-Turn products.



NOTE

Unless otherwise stated, the new features and functionality listed in this section apply to both Lathe and Mill-Turn licenses.

B-Axis Contour Turning Enhancements

Three major enhancements have been added to the B-Axis Contour Turning operation:

- Ability to manually edit tool axis vectors.
- Ability to manually edit usable insert area.
- Adjust stock function.

Together, these new features give you even more control over how the tool contacts the part. These enhancements further the optimization of tool life and surface finish, while also streamlining the workflow.

Editing the Toolpath Vectors

If you have manually defined the tool axis vectors, Mastercam now lets you edit them after they have been created. Do this to fine-tune the resulting toolpath without editing or creating additional geometry.

The new options are on the **Basic Motion Control** page. Select **Modified**, and then click the **Edit vectors** button.

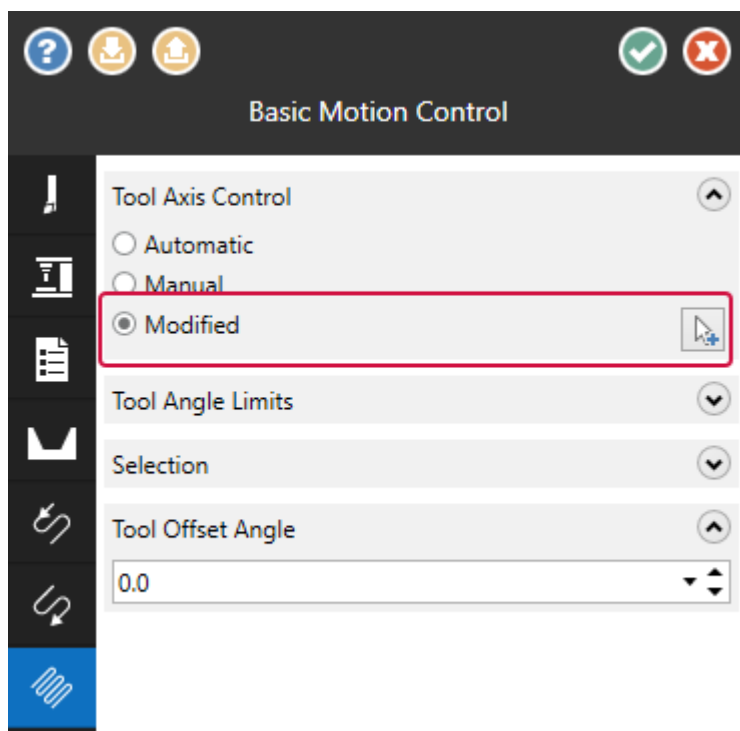

Mastercam displays the current tool axis vectors in the graphics window. Click on a vector and use the angle dial to rotate it to the desired orientation. Press the [Shift] key to display an outline of the tool along with the vector. While you are editing the vectors, the tool rotation is stopped and boundary is displayed in red if a collision is detected.

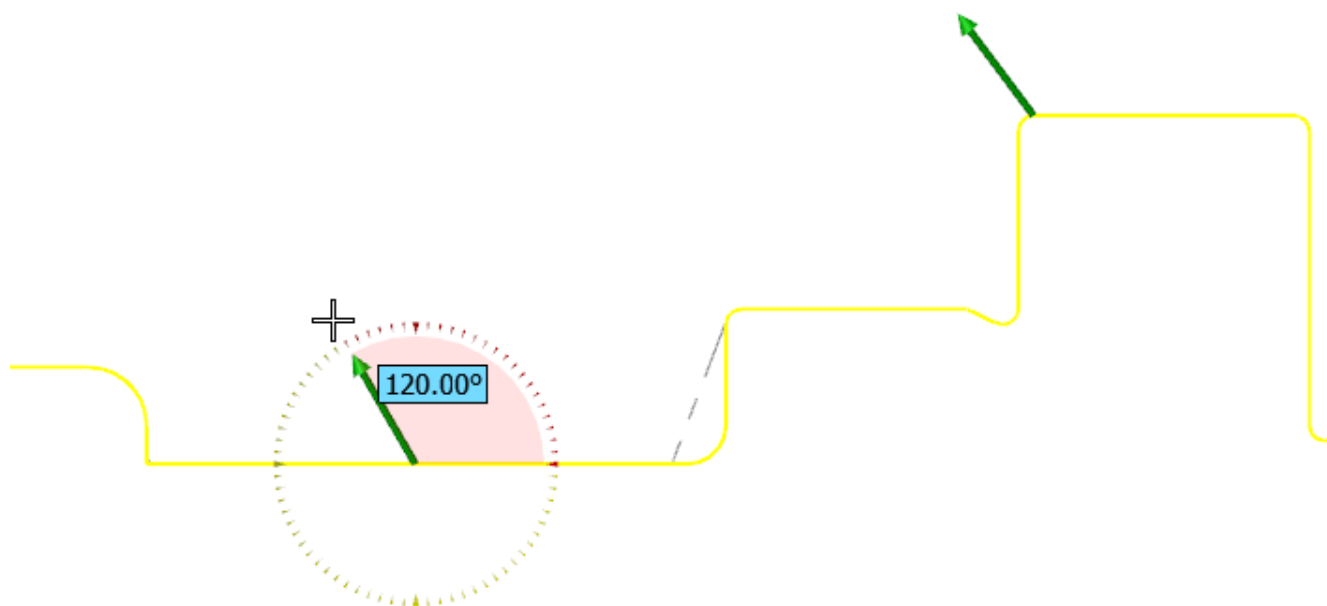
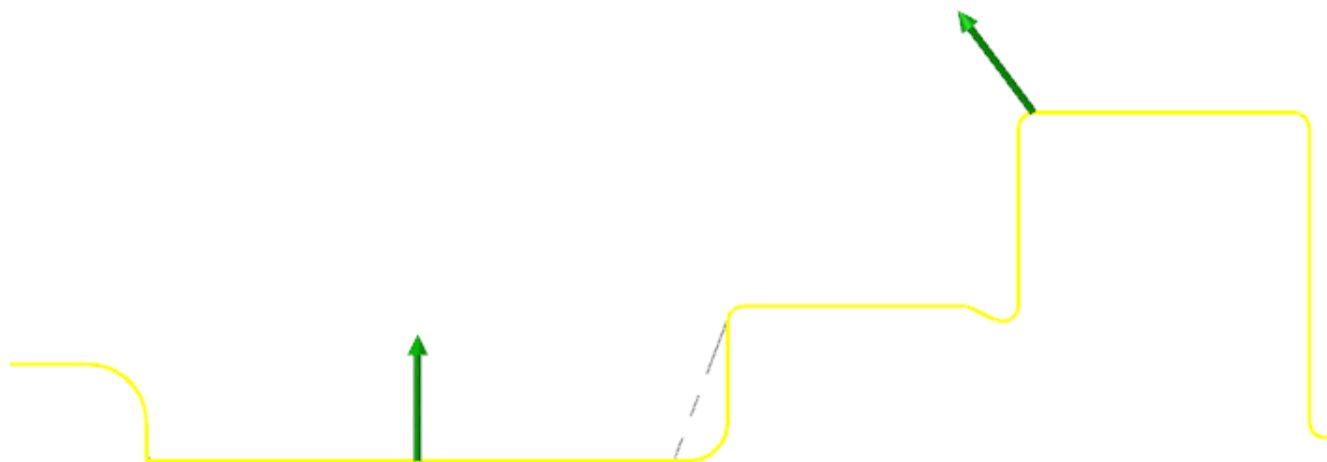

Double-click anywhere on the contour to add additional tool axis vectors. Sections of the contour, where the tool is not able to contact the part, are highlighted in red; if you double-click in a non-contact area, Mastercam will add the new tool axis vector at the closest possible location.

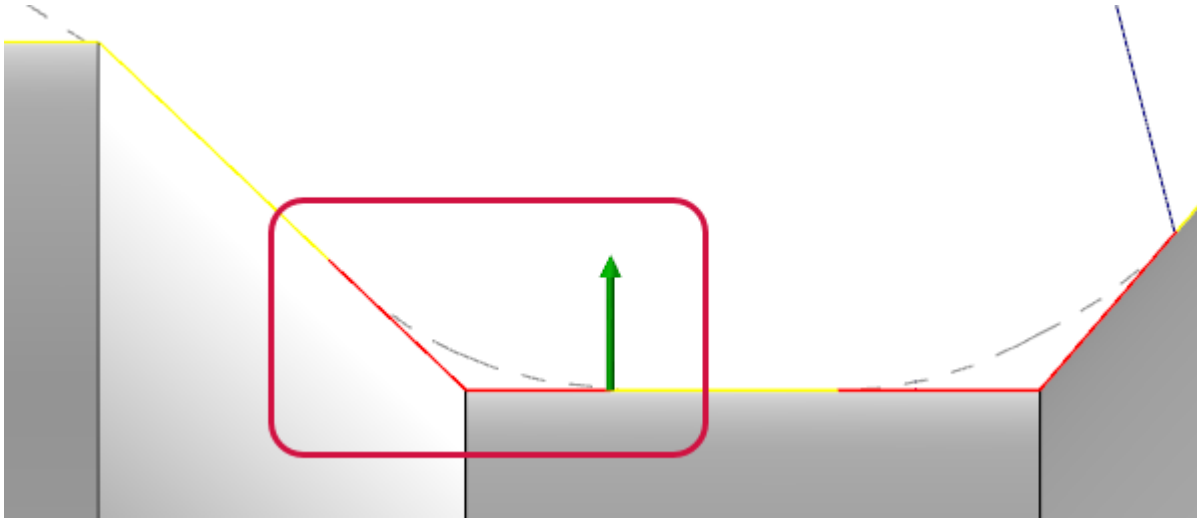

Press [Enter] to return to the function panel. Mastercam does not edit the original wireframe geometry that was used to create the initial tool axis vector.

Note that if you are working with a part that was created in an earlier version of Mastercam with the **Automatic** setting, you will need to regenerate the part before the **Modified** option is available.

Manually Defining the Usable Portion of the Insert

Mastercam now lets you manually define the allowable portion of the insert. Do this when you would rather define the insert visually instead of entering a dimension, or when you wish to define a usable insert area that is irregular or non-symmetrical.

The new options are on the **Advanced Motion Control** page. Choose **Manual**, then the **Edit depth** button. Mastercam returns you to the graphics window where you can edit the boundaries of the usable portion. Use your mouse to drag each colored ball to the desired location on the insert boundary.

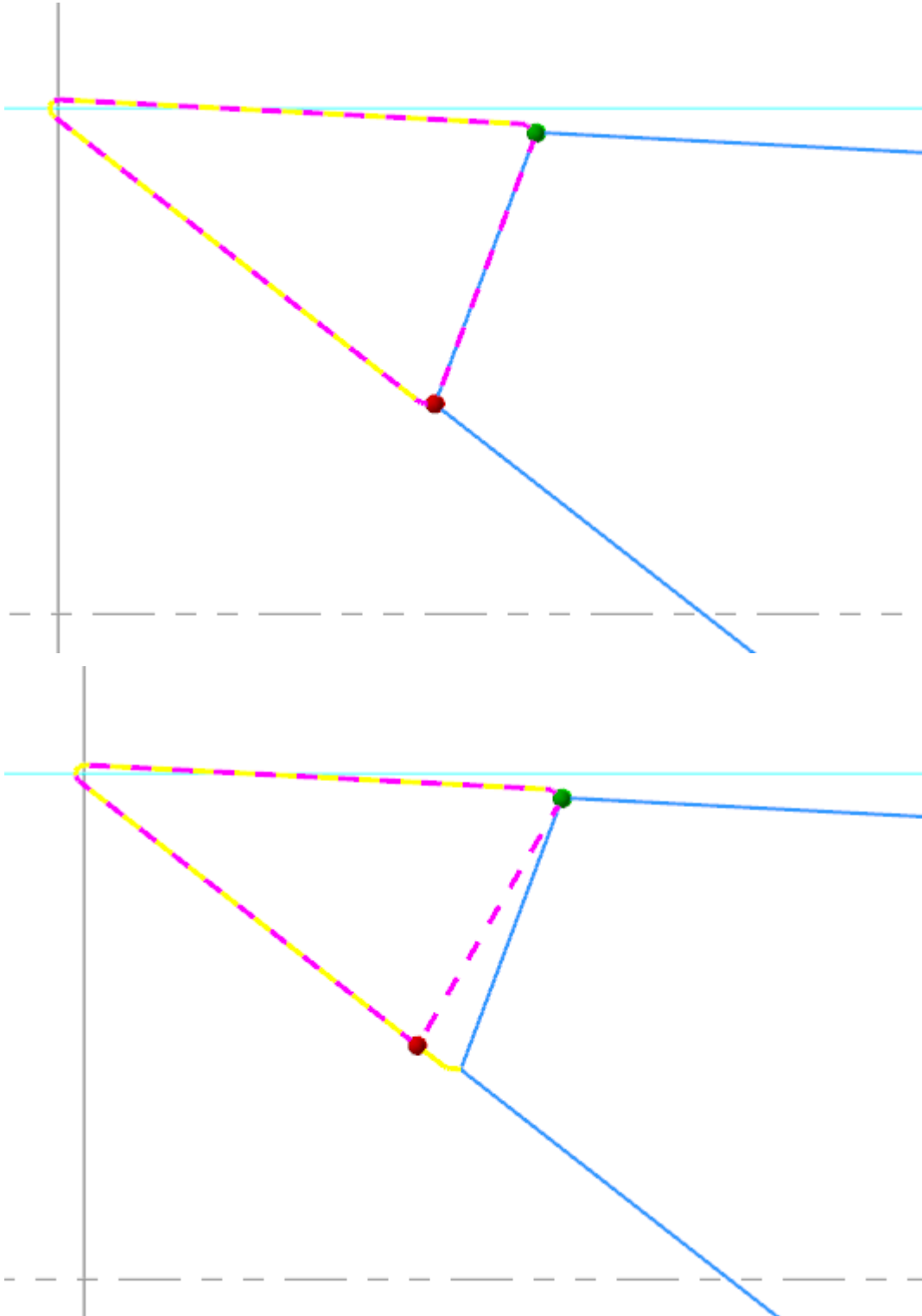

Also, a new **Preview** button has been added. Click it to see the updated insert boundaries in the graphics window. This can be used no matter which method you use to define the usable insert area.

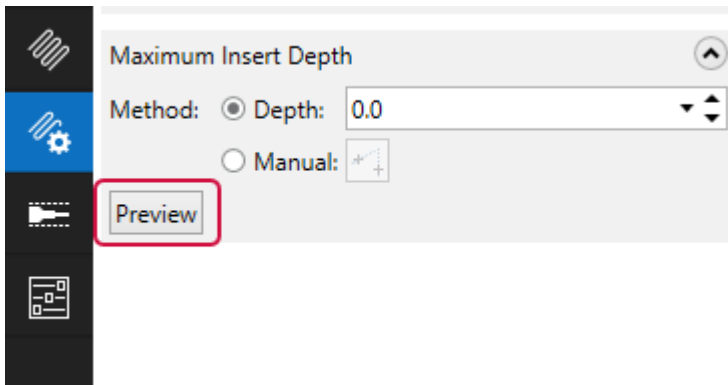

- Mastercam displays the insert with the proper insert-up or insert-down colors.
- The display takes into account the **Holder clearance** value.
- For collision-checking purposes, the unused portion of the insert is treated like it is part of the holder.

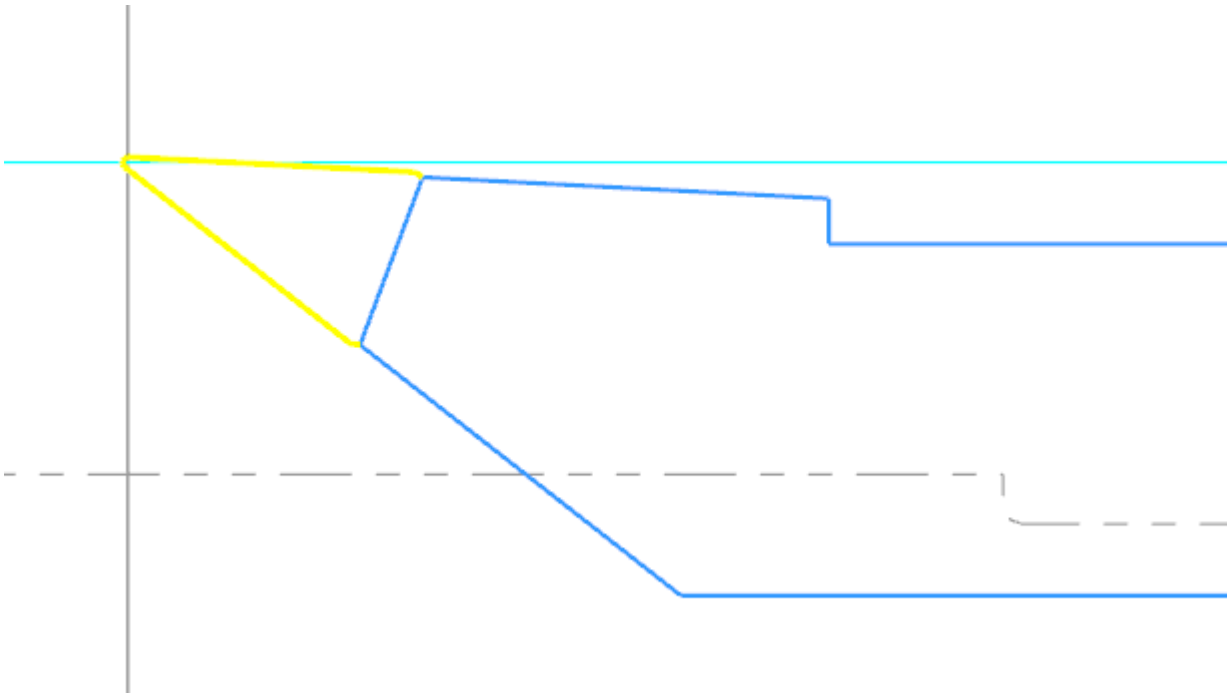

Adjusting the Stock

Many turning operations in Mastercam include the **Adjust stock** function. B-axis Contour Turning operations now also include this feature. However, the interface has been completely redesigned for an easier workflow.

Click **Adjust stock** to edit the stock model at the beginning and end of the toolpath. Do this to control how the tool enters and exits the stock.

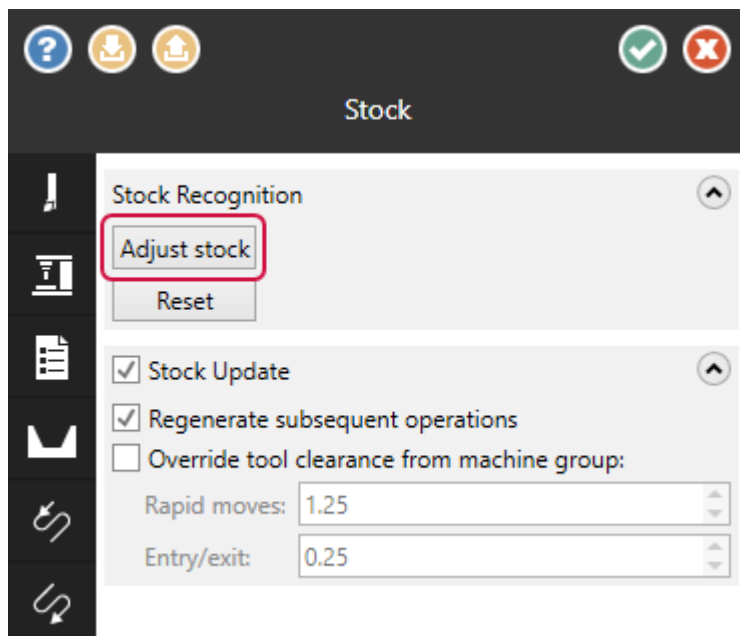

When you click the button, Mastercam displays the existing remaining stock model relative to the chained geometry in a temporary viewsheet. A green ball indicates the beginning of the chain, and a red ball indicates the end. The gray dashed line indicates the current stock boundary.

Click and release one of the balls to edit the stock model at either end of the chain. Drag the ball to the desired location on the stock boundary, and then press [Enter].

White dots indicate up to three locations to which the cursor will snap:

- The location perpendicular to the direction of the cut.
- The location parallel to the direction of the cut.
- The location parallel to the direction of the chain.

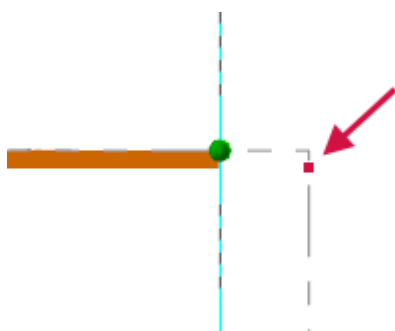

In these pictures, the white dots are displayed in red for sake of clarity. For example, you can drag the ball to the stock margin to extend the stock to the face of the part, or drag it down to create a chamfer.

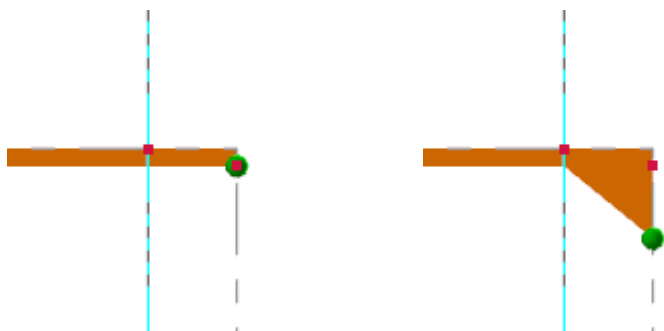

When you are done, click [Enter] to return to the function panel. Click **Reset** to undo the changes and restore the original stock.

Using Turret-Mounted Angled Milling Heads

You can now use turret-mounted angled milling heads in Mill-Turn operations. This lets you create toolpaths on angled planes using turret-mounted tools.

Prior to Mastercam 2024, tool locators for turrets supported both turning tools and milling tools in live tooling stations. While turning tools could be mounted in an angular orientation, live tools could not.

Mastercam 2024 divides turret tool locators into two separate component types: one for turning tools, and a second for milling tools. You can create milling tool locators for face milling, cross milling, or at an angular orientation. You can specify a fixed angle in the component properties, or read the orientation from the operation. This lets you create tilted plane, G68-style toolpaths with turret-only machines.

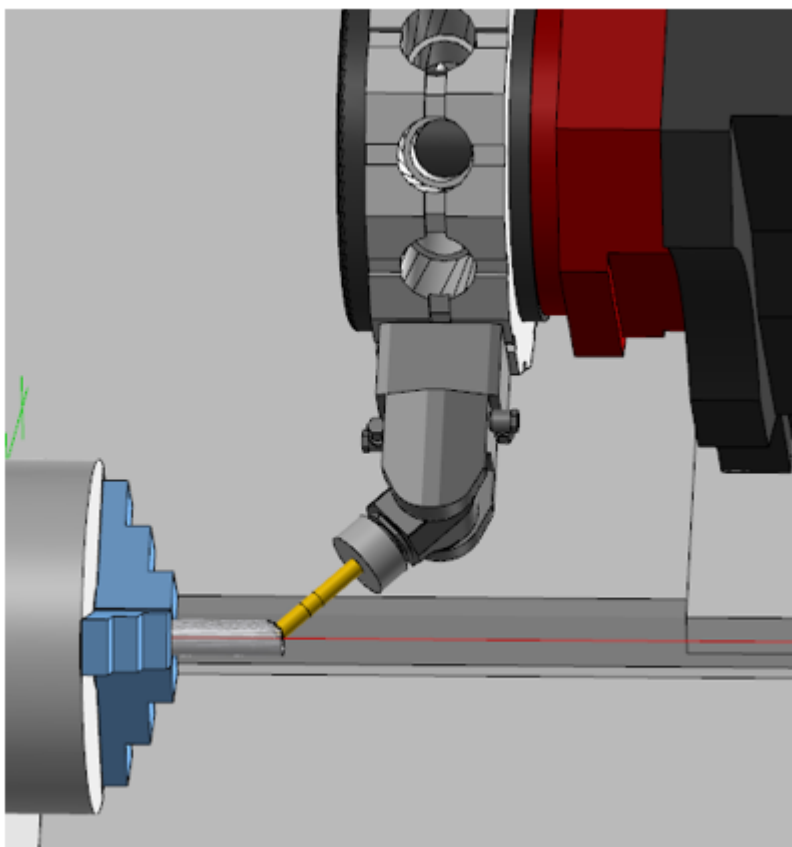

Using Angled Milling Heads in Operations

When Mastercam detects that angled milling heads are available or when you load a tool into an angled milling head, Mastercam enables the **Plane Rotation** option in the **Setup** page.

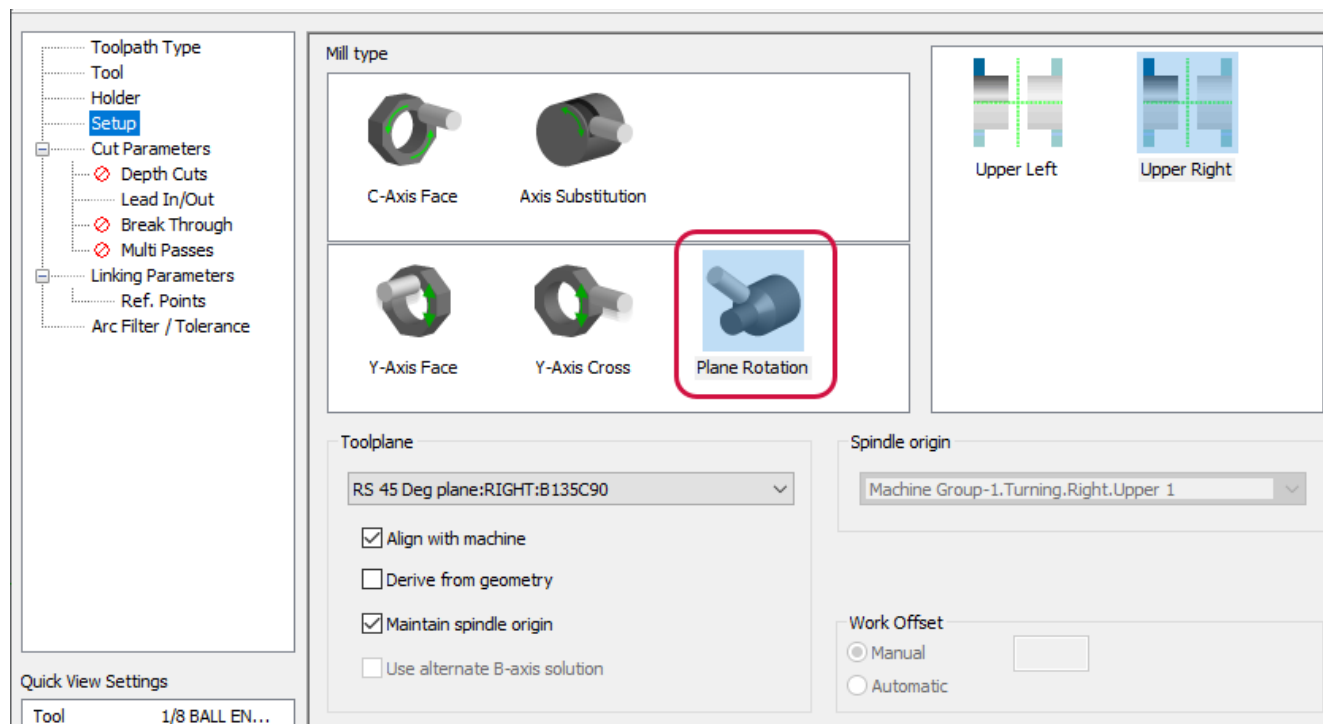

Typically this setup type is not available for turret-only machines, but will be required whenever the milling head is oriented at any angle other than 0 or 90 degrees. The orientation of the head also filters the allowable axis combinations.

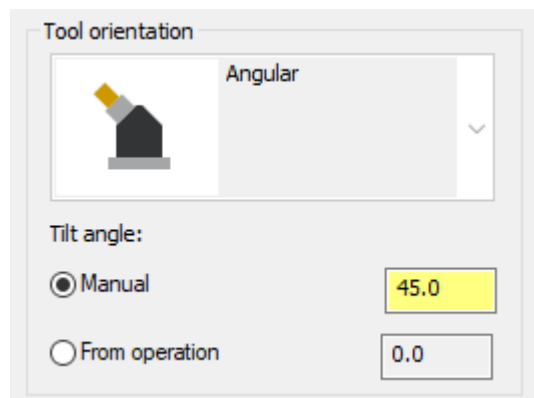

Angled heads can be created with a fixed angle, or you can configure them to get the angular orientation from the operation. This affects how you set the toolplane.

- If the head is set to a fixed angle, you will typically want to ensure that the orientation of the toolplane matches the angled head. If it does not, Mastercam displays a warning message.
- If the head is set to read the angle from the operation, you will be able to select a toolplane with your operation, or select **Derive from geometry** if your toolpath geometry supports it.

Once a tool has been selected for an operation and mounted in an angled milling head, you cannot change the tool number. The only way to change the tool number is to select a new tool or delete the operation. The **Assign tool numbers sequentially** option in your machine group is not applied to tools mounted in angled milling heads.

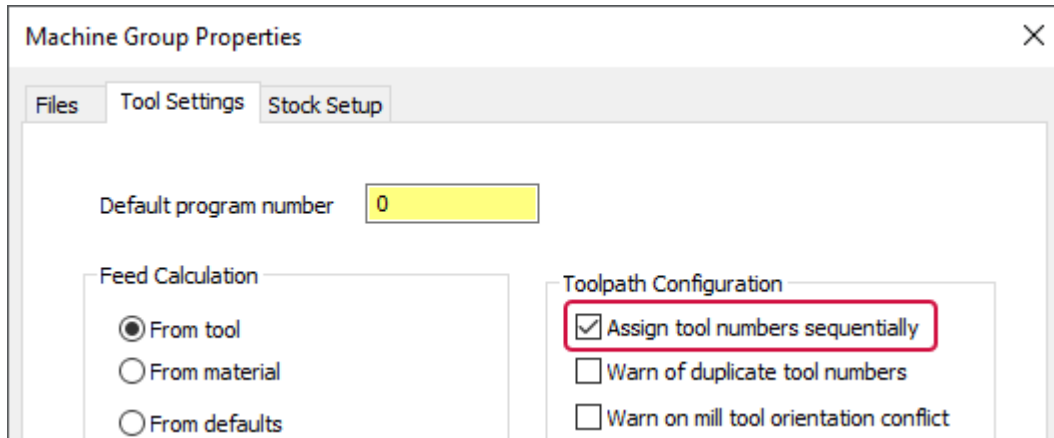

Some live tooling heads are geared to increase, decrease, or reverse the programmed spindle speed. These settings are available in the component properties for the tool locator. The spindle speed adjustment will be applied automatically when you select the angled head.

Tool Locator Components

To implement the new functionality, the component architecture for tool locators has been overhauled. You will see this first when you add a new locator to a turret, and need to choose from the two different types:

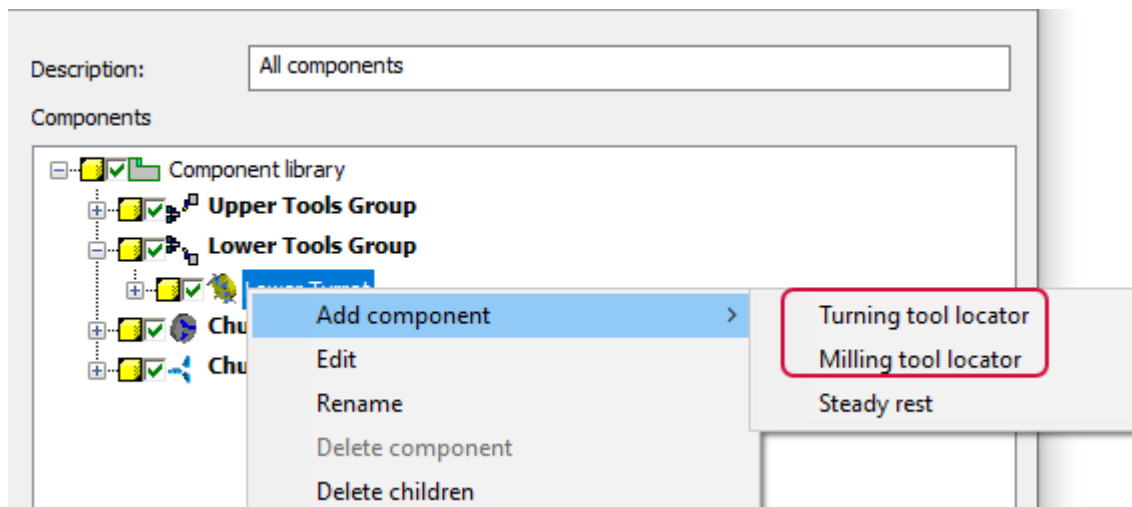

The interface for both turning and milling tool locators has been redesigned for a smoother workflow, using the same interface that was introduced for steady rest components.

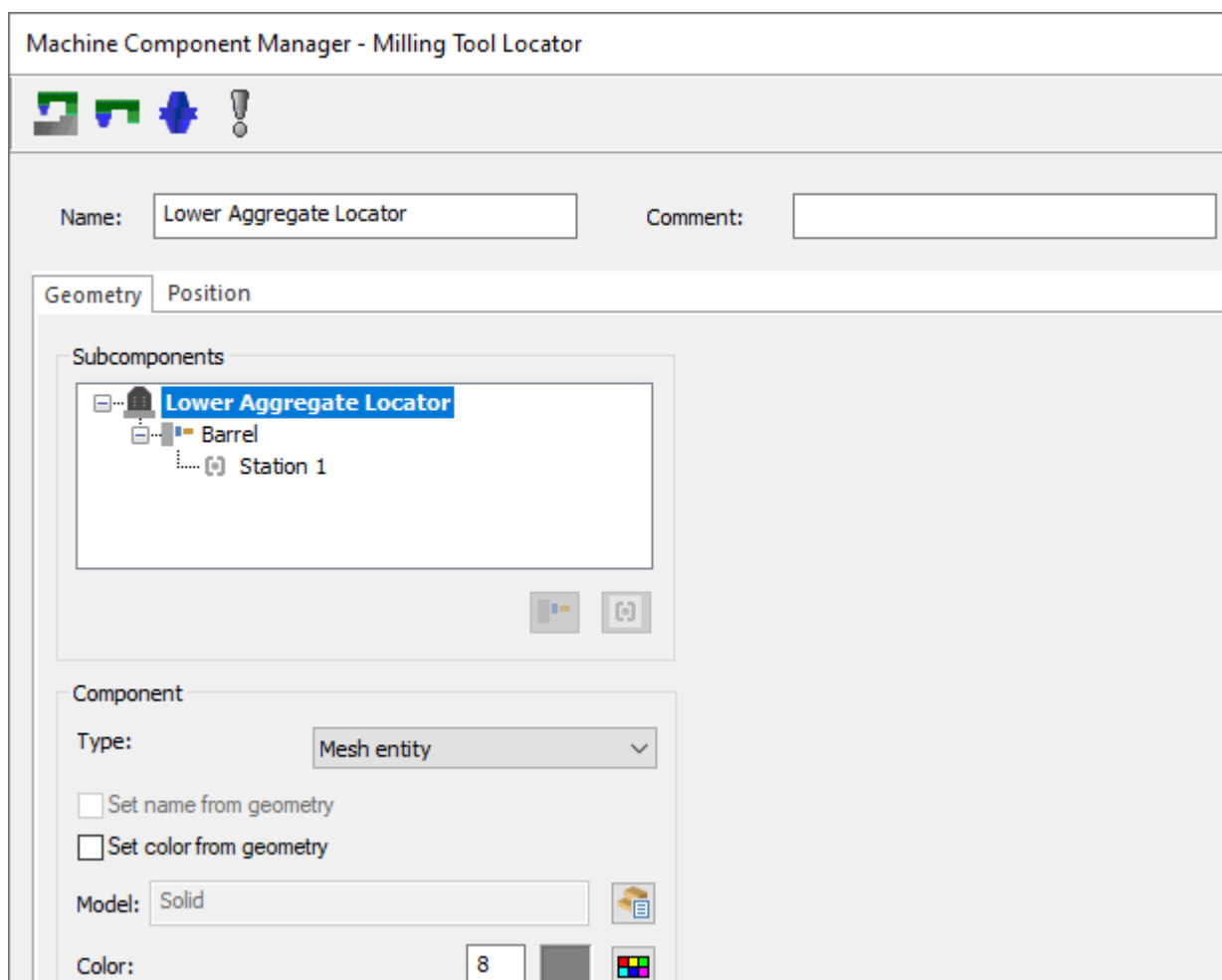

Milling tool locators can include a barrel subcomponent. This represents the portion of the locator that rotates, and typically is associated with its own solid model. A barrel is optional; you do not need to include one if it is not necessary. In the picture below, the orange model is the barrel subcomponent.

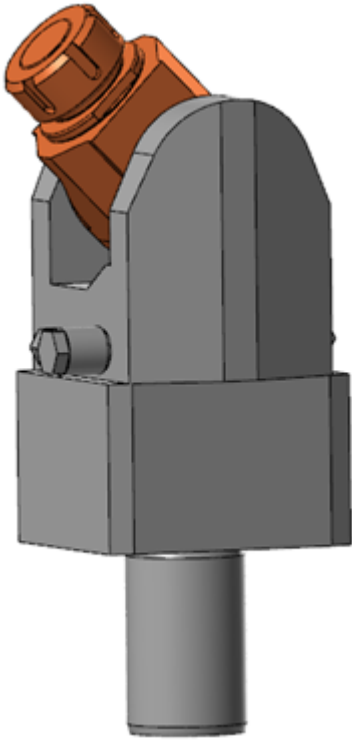

The key properties of the barrel are the center of rotation, the angular travel limits, and the solid model.

Machine Component Manager - Milling Tool Locator

Name: Lower Aggregate Locator - multiplier 2.0 Comment:

Geometry Position

Subcomponents

- Lower Aggregate Locator - multiplier 2.0
 - Barrel
 - Station 1

Center of Rotation

X: 0.0
Y: 2.362205
Z: 0.0

Travel Limit (From Straight)

Minimum angle (deg.): -90.0
Maximum angle (deg.): 90.0
Angle resolution: 0.001

Component

Type: Solid entity

Set name from geometry
 Set color from geometry

Model: solid

Color: 8

Chord tolerance: 0.001

Finally, each locator component includes one or more tool stations.

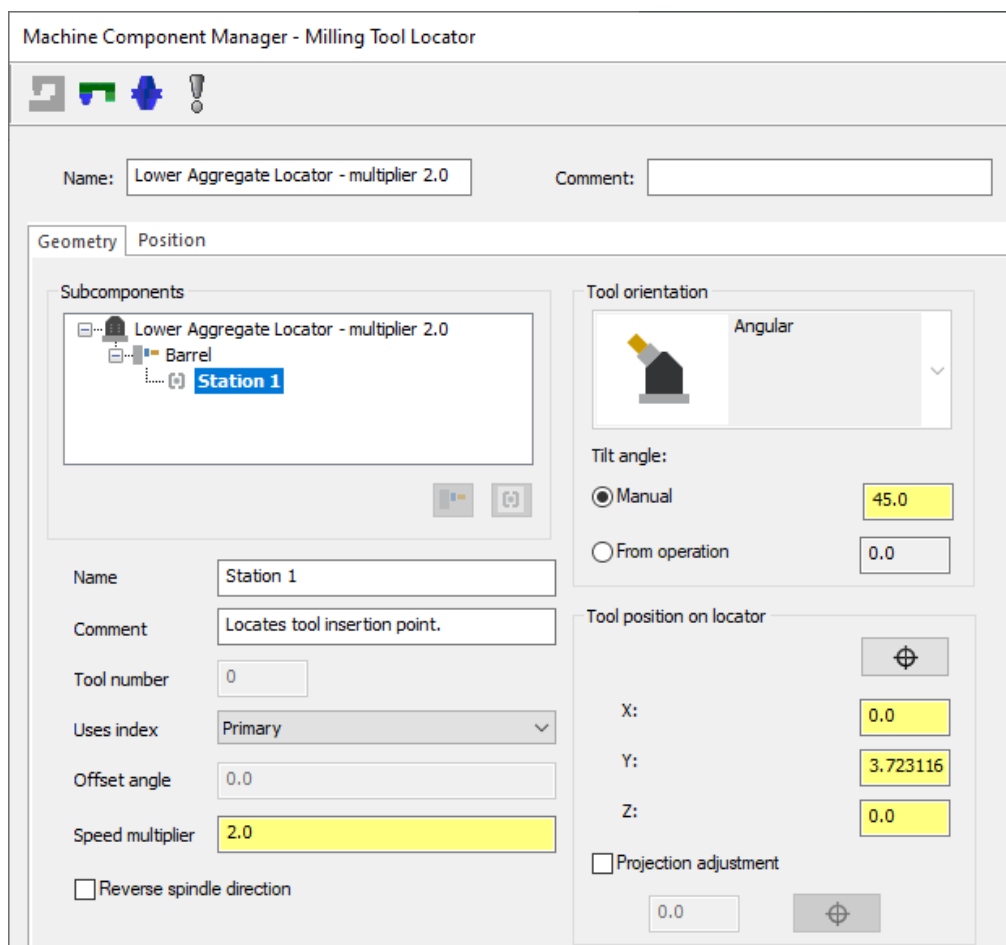

Milling tool locators can be oriented for face milling, cross milling, or angular. Face- and cross-milling tool locators support multiple stations per locator, while angled heads allow only one.

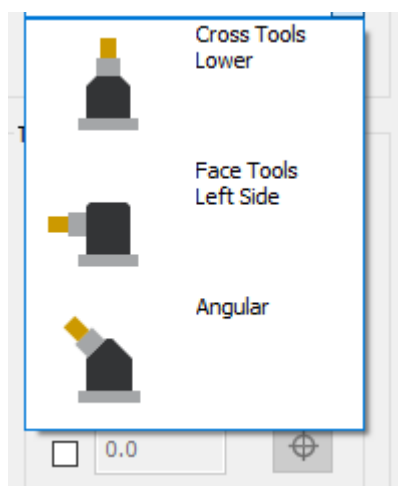

Angled heads can be locked to a fixed angle (select **Manual** and enter the angle), or can be set so that the angular orientation comes from the operation. Other new properties include a **Speed multiplier** factor plus the ability to **Reverse spindle direction**; these should be set to match the internal gearing on your head.

Creating a New Spindle Origin for Spindle Move Operations

Spindle move operations now give you the option to define a new spindle origin at the new location. This creates an entire set of planes whose origin is at the new location. Use these as tool planes for operations that you create at this location. The name that you enter in this dialog box for the destination will be used as the name for the new views. You can also choose to associate a work offset with the new location; this will be invoked automatically whenever you use one of the new planes.

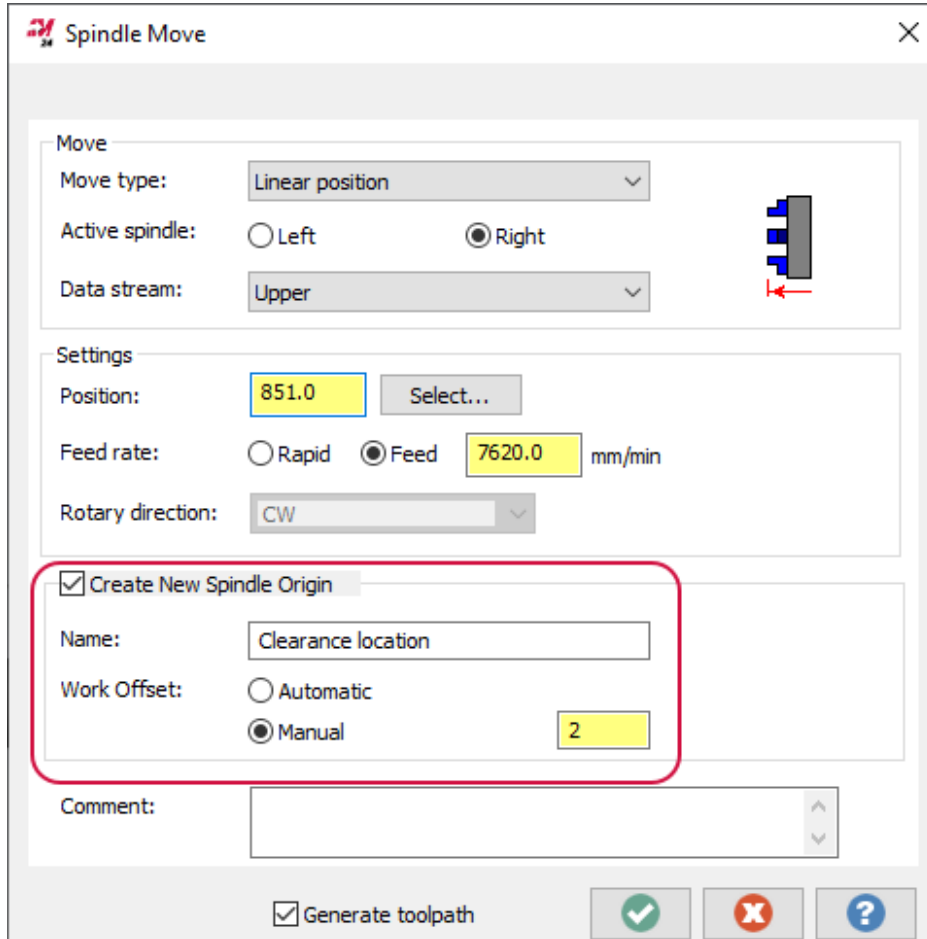

The screenshot shows the 'Spindle Move' dialog box with the following settings:

- Move**
 - Move type: Linear position
 - Active spindle: Left Right
 - Data stream: Upper
- Settings**
 - Position: 851.0 (with 'Select...' button)
 - Feed rate: Rapid Feed 7620.0 mm/min
 - Rotary direction: CW
- Create New Spindle Origin** (highlighted with a red box)
 - Create New Spindle Origin
 - Name: Clearance location
 - Work Offset: Automatic Manual 2
- Comment: (empty text box)
- Generate toolpath:
- Buttons: Checkmark, X, Question mark

In addition, while bar feed operations already support this feature, the layout of the **Bar Feed** dialog box has been refreshed so that it matches the look of the **Spindle Move** dialog box.

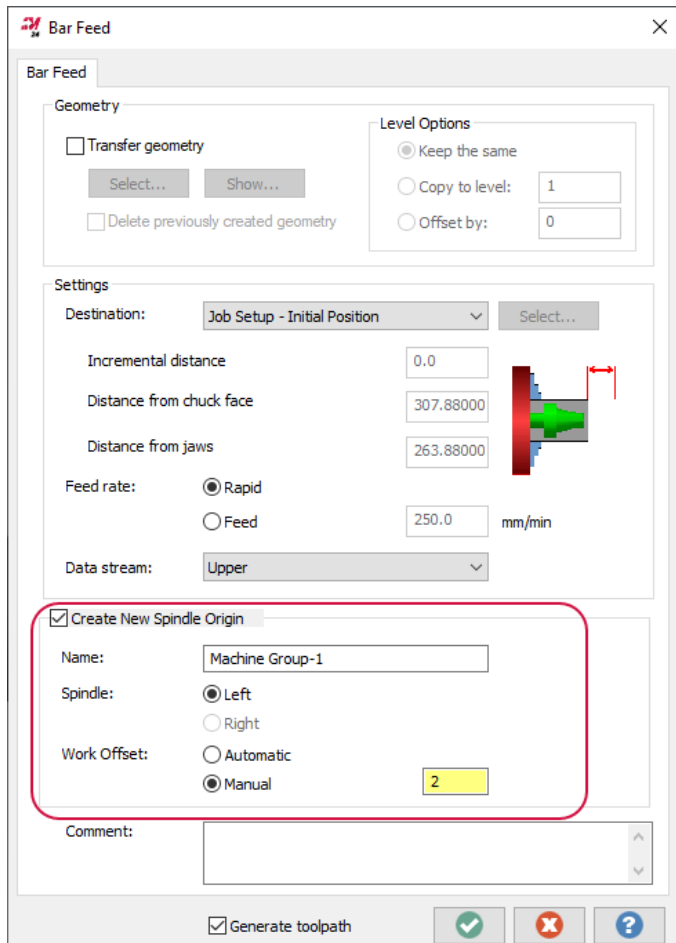

Creating Separate Lead In/Out Moves for Semi-Finishing Passes

Dynamic Roughing toolpaths now let you create separate lead in/out moves for semi-finishing passes. Since most of the stock will have been removed by the roughing passes, this lets you create more compact and efficient moves for the semi-finishing passes. The only difference is that lead in/out moves for semi-finish passes cannot include any modifications to the chained contour; these options will not be present for the semi-finish passes.

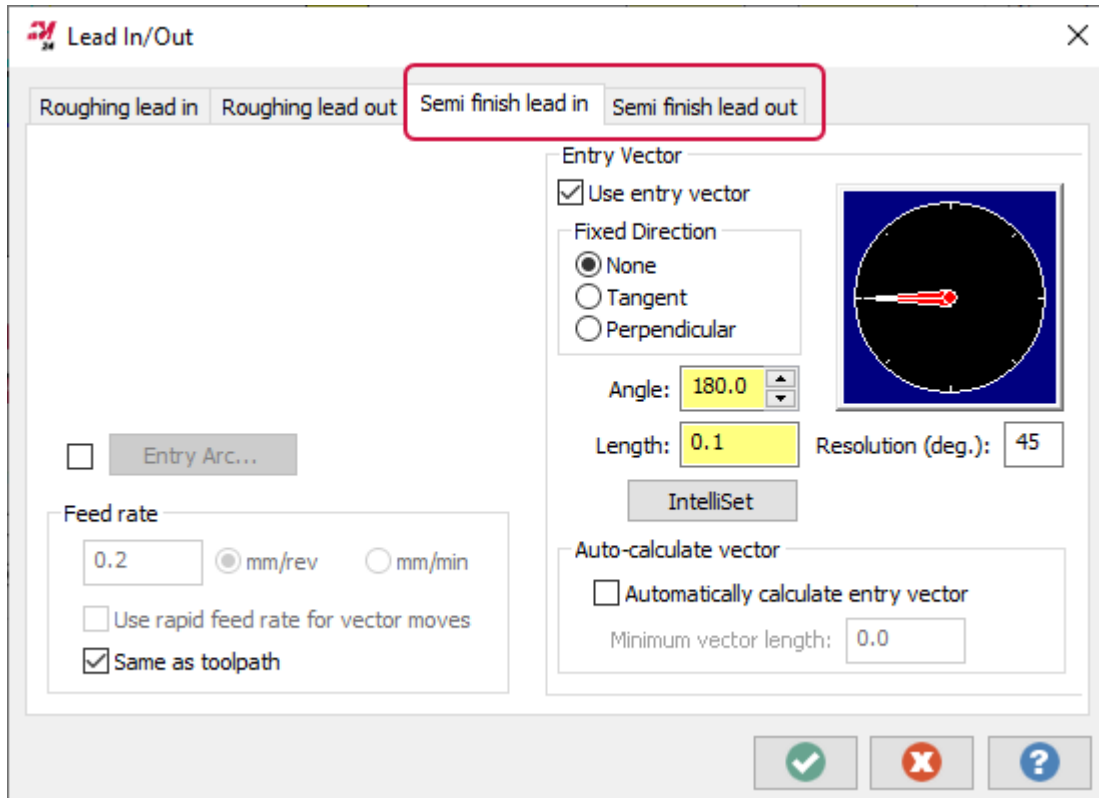

Enhancements to Variable Depth of Cut for Lathe Rough

Lathe Rough toolpaths now let you adjust the depth at the start of the cut by up to 100% of its calculated value. Previously the adjustment was limited to 25%. This lets you vary the point that the surface contacts the tool insert to prevent notching and to improve tool life. This results in an angled cut:

- A value of 100% means that the cut will be twice as deep at the end of the pass.
- A value of -100% collapses the cut, resulting in an effective cut depth of 0.

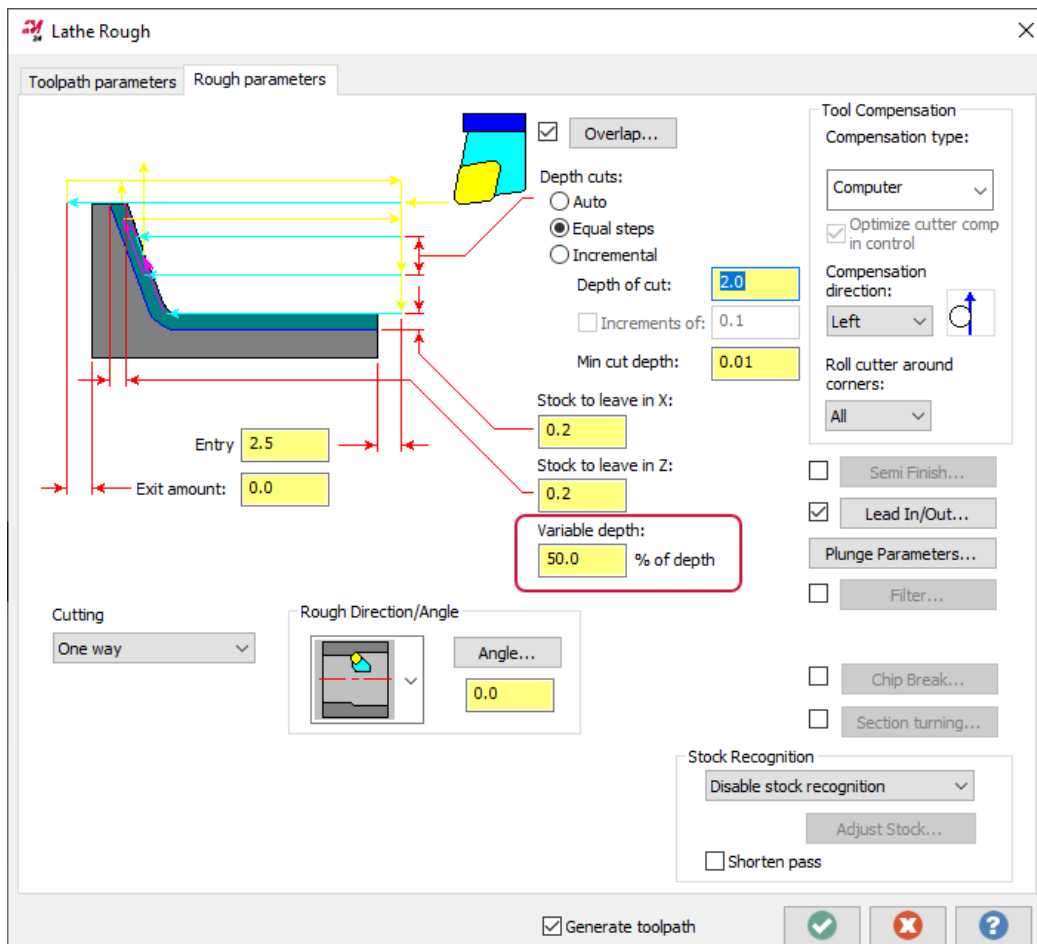

The adjustment is applied to alternate passes, meaning that your cutting passes will alternate between straight and angled cuts. However, in flat areas, a straight cut will be made instead of an angled cut. If the cut length is less than the cut depth, a straight cut will be made instead of an angled cut.

All cutting pass types are supported, as well as ID, OD, face, back, and angled cuts.

Designing Enhancements

Listed below are major enhancements to designing functions.

Controlling the Orientation of Disassembled Solids or Mesh Bodies

By default, Mastercam orients disassembled solid and mesh bodies on their largest, flat face. In previous versions of Mastercam, the only way to control the orientation of the disassembled solids was to enable **Face Selection** and disable **Body Selection** on the **Selection Bar**. This action made it possible to place specific faces on the layout plane. Unfortunately, you could not use this method if the opposing faces of the selected bodies were equal.

To provide more control in these situations, Mastercam 2024 lets you use the color of a face to orient the disassembled bodies. To do this, click the **Sample color** button in the **Disassemble** panel's **Face Color** section and choose a color from the graphics window.

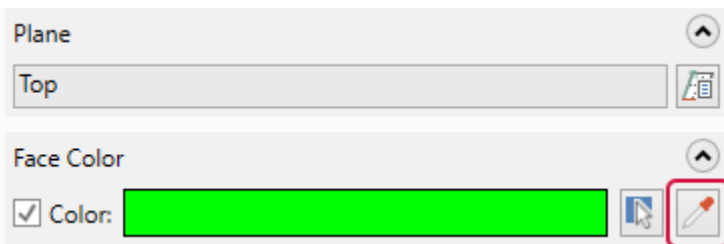

If you cannot easily select the face color in the graphics window, you can also click **Select color** to choose a color from the **Colors** dialog box. Mastercam continues to disassemble the part placing the largest, flattest face of a body towards the layout plane. However, it will also place any face of this color that is the same size of its opposing face towards the layout plane.

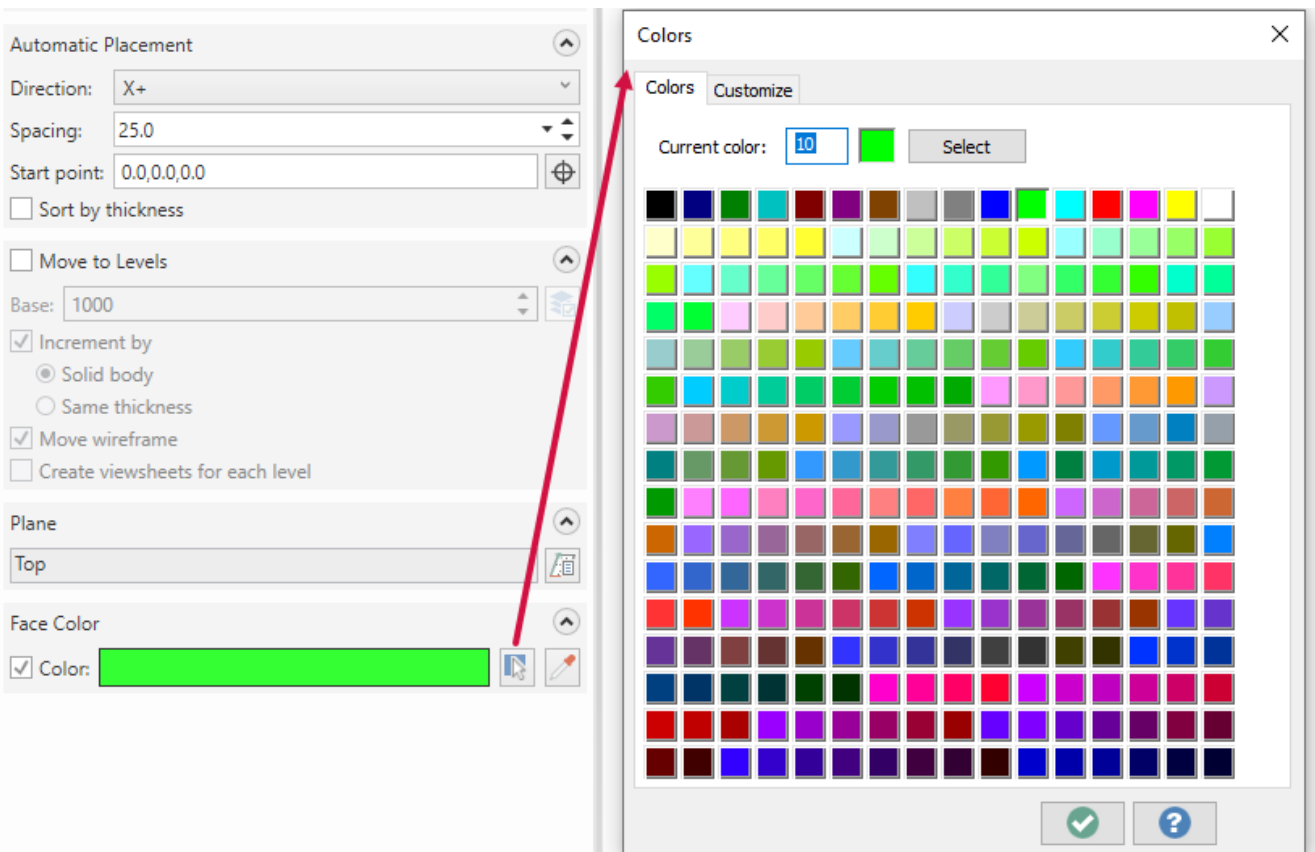

Solid Hole Enhancements

There have been many enhancements to Mastercam's hole-making functions. Many of these will be helpful in your drilling and Process Hole operations.

Easily Smooth the Edges of Solid Holes

Mastercam 2024 now offers an easy way for you to break the hole edges in solid parts. Hole operations in this release now include options for edge treatment from within the function panel.

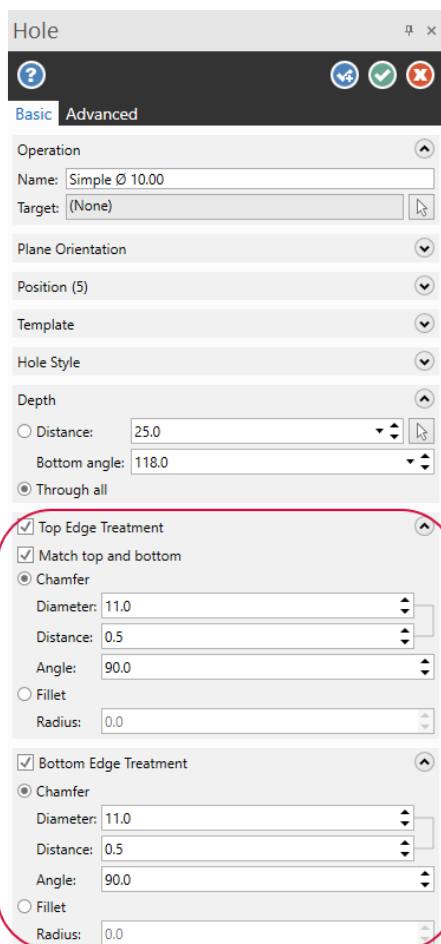

While in previous versions of Mastercam, you could only create a chamfer at the top edge of a hole, Mastercam 2024's new **Top Edge Treatment** parameters allow you to create either chamfers or fillets on your hole edge. Mastercam has also expanded options to generate a chamfer by giving you the option to specify the size of the chamfer by entering either its diameter or its width distance.

Additionally, you can now smooth the bottom edges of through holes. Simply select the **Match top and bottom** option to apply your top edge treatment settings to your bottom edge, or enter specific values into the **Bottom Edge Treatment** section in the function panel.

Creating New Operations from a Single Hole Operation

Mastercam 2024 makes incorporating design changes to existing holes in your solid easier. New options in the Solids Manager and the Hole panel allow you to create, move, or copy hole operations from hole operation groups.

In the Solids Manager, the **Explode hole operation** option creates an operation from each instance in a group of holes. For example, to create eight, separate operations from a single operation with eight holes, select the **Explode hole operation** command from the Solids Manager's right-click menu. Mastercam instantly creates and displays each operation in the Solids Manager.

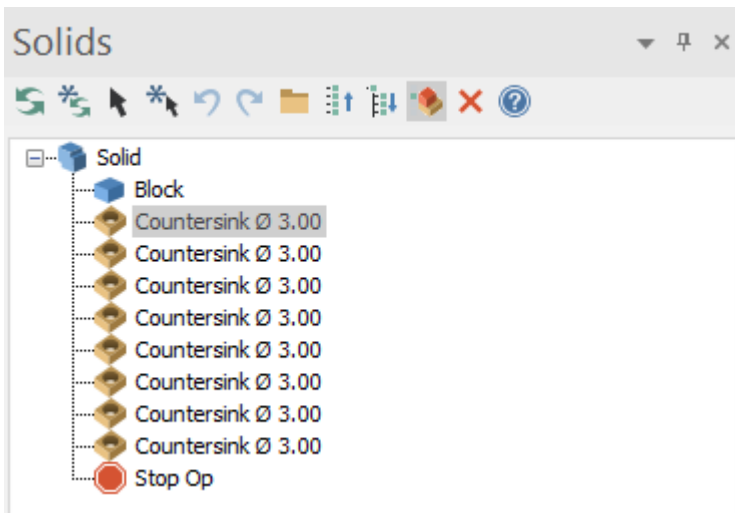
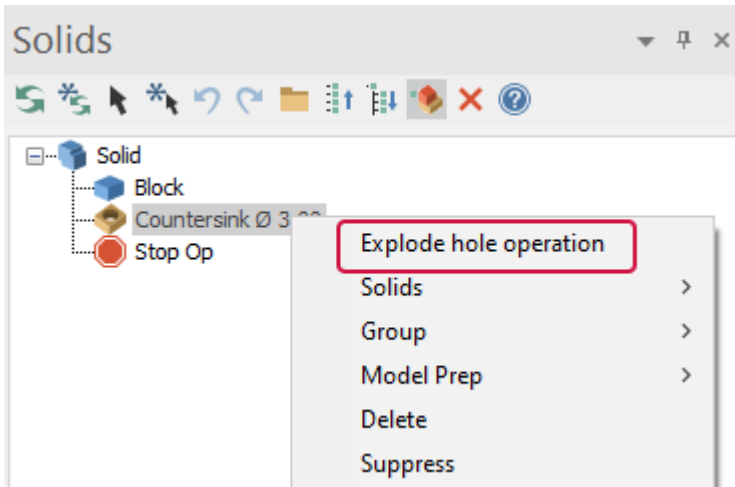

To apply design changes to specific groups, open a Hole operation from the Solids Manager. Select the individual hole positions in the Hole panel and choose the **Move to new operation** or **Copy to new operation** commands from the right-click menu. Then, click **Regen** on the Solids Manager toolbar. The new, independent operations are reflected in the Solids Manager.

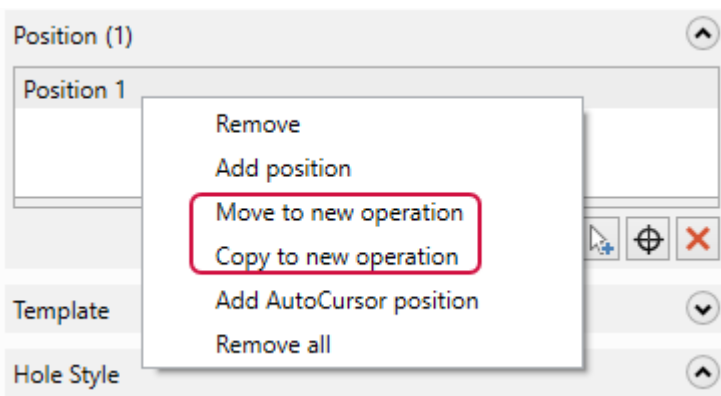

Changing the Direction of Existing Through Holes

In Mastercam 2024, we have added a new **Reverse Hole** button to the **Hole** function. This option allows you to flip the direction of selected through-holes. It moves the hole's associative point (the point that was selected to create the hole) to the opposite end of the hole and reverses the vector (the direction of the hole).

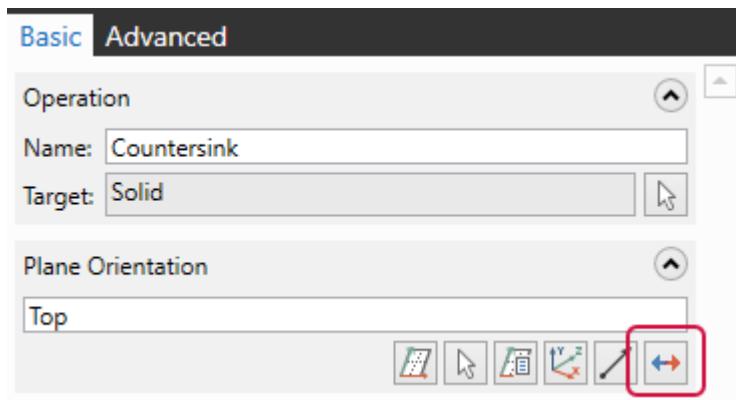

NOTE

To enable this feature, you must have **Through all** selected in the panel's **Depth** option group.

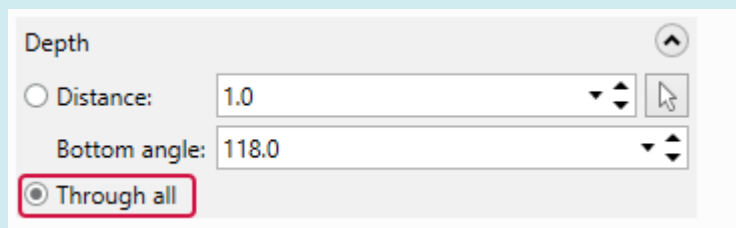

Modifying Your Drafting Dimensions Directly

Mastercam 2023 introduced in-panel methods to the **Drafting** function panel to modify font format and drafting entity placement. This enhancement removed the extra steps necessary to make modifications. Mastercam 2024 expands those changes.

The new **Drafting** panel incorporates dimension attributes, text, and witness and leader settings into three new pages. This eliminates the need to exit the panel and edit these settings in the **System Configuration** dialog box.

In addition to the **Basic** and **Advanced** pages available in previous versions, there are three new panel pages.

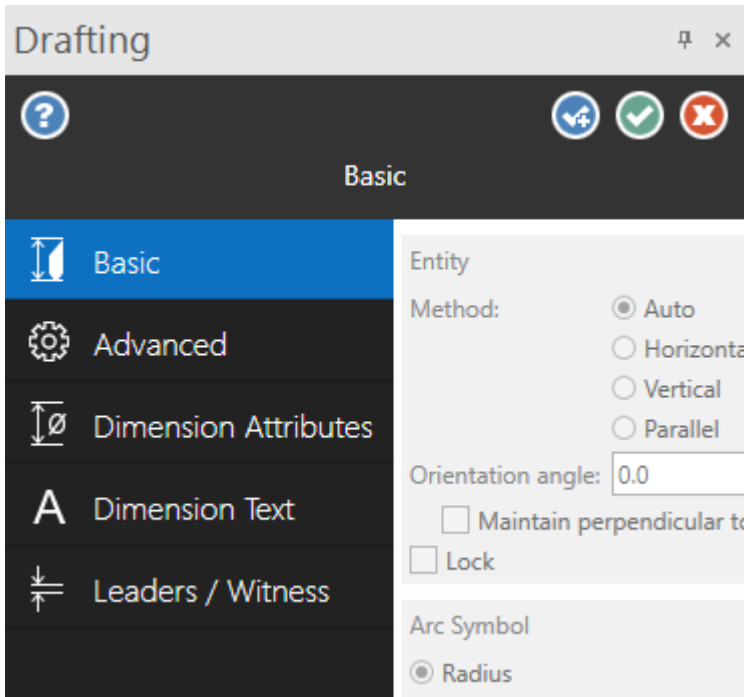

- **Dimension Attributes:** Sets properties for coordinates and symbols.
- **Dimension Text:** Sets properties for text size, point dimensions, text direction, and text orientation.
- **Leaders/Witness:** Sets properties for leaders, witness lines, and arrows.

The changes you make in the function panel do not change Mastercam's default settings. If you need to make changes to the defaults, use the pages in the **System Configuration** dialog box.

Trim, Break, and Extend Wireframe Entities from One Function

With the new **Dynamic Trim** function, Mastercam 2024 reintroduces multiple trimming functions into a single panel. **Dynamic Trim** combines the **Trim to Entities**, **Divide**, **Trim to Point**, and **Modify Length** into one panel so that you can easily apply any of these functions to wireframe geometry without having to open a separate panel. This new function is located on the **Wireframe** tab.

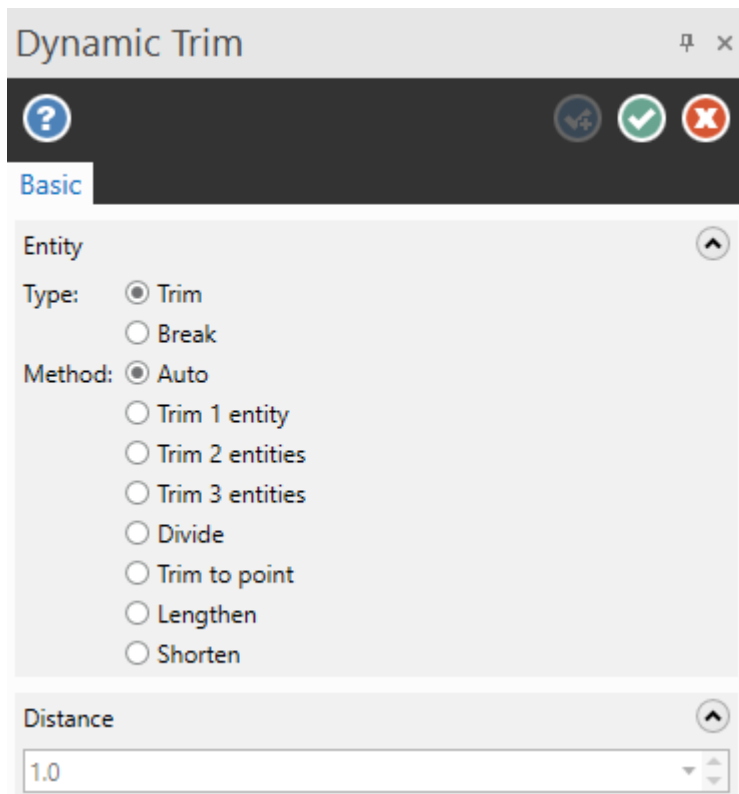

If you are more comfortable using the functions separately, you can still access each one individually from the same **Modify** group on the **Wireframe** tab.

Smoothly Attach Spline Endpoints

Mastercam 2024 adds more improvements to wireframe modification. A new option in the **Edit Spline** function creates a smooth transition from the endpoint of the selected spline to an endpoint on another entity.

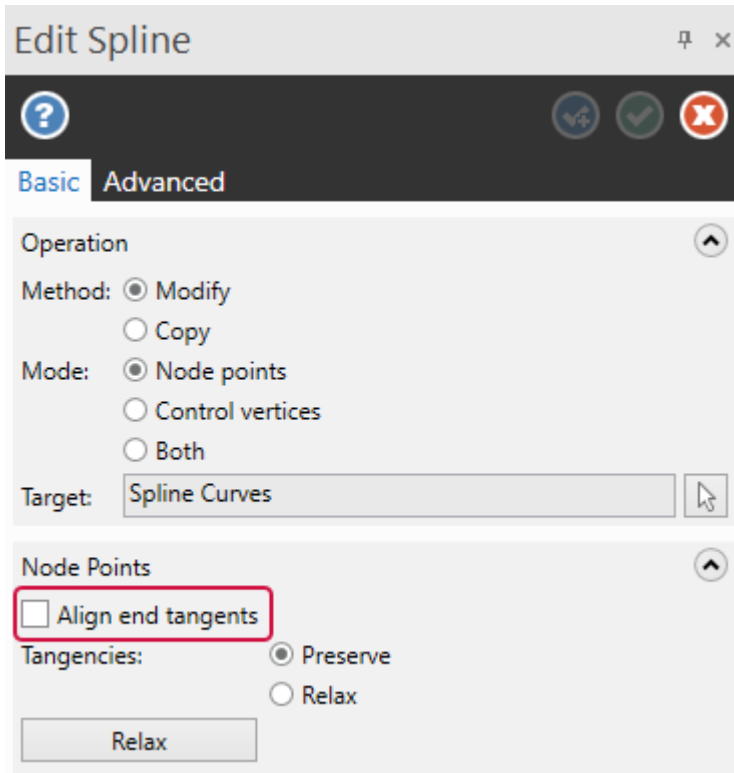

When you select the **Align end tangents** option in the panel, Mastercam matches the tangency of the repositioned spline endpoint to that of the destination endpoint. The blended geometry results in a continuous curvature of the geometry and a better foundation for surface creation.

Note Workflow Improvement

Mastercam 2024 improves efficiency with a simple change to the **Note** workflow. In previous versions of Mastercam, you would have to interact with the panel every time you wanted to add or delete a leader line to a note.

Now, you can simply indicate the new position in the graphics window to add additional leader lines. To delete the last leader added, press [Esc]. The leader workflow remains live until you press the [Enter] key.

Simulation Enhancements

Listed below are major enhancements to Mastercam Simulator.

New Mastercam Simulator Workflow for Mill and Router Machines

Starting with Mastercam 2024, the **Simulator Options** are changing to help reduce redundant workflows, and provide one single location for all settings related to the active machine group and Mastercam Simulator. Mastercam Simulator now only uses the information in the **Machine Group Setup** panel to populate the simulation. Options previously found in the **Simulation** and **Data** tabs of **Simulator Options** dialog box are now in the **Simulation** panel. The **Simulator Options** button is still available for lathe, mill-turn, and wire machine groups.

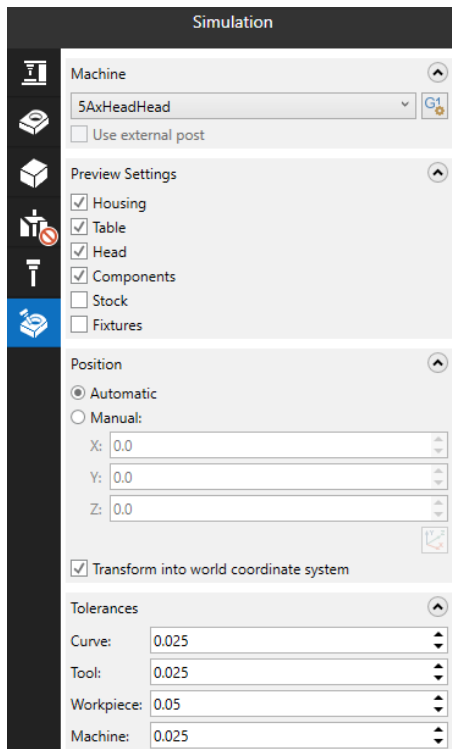

The options in the **Components** tab are now in the **Stock Setup** and **Workholding** pages.

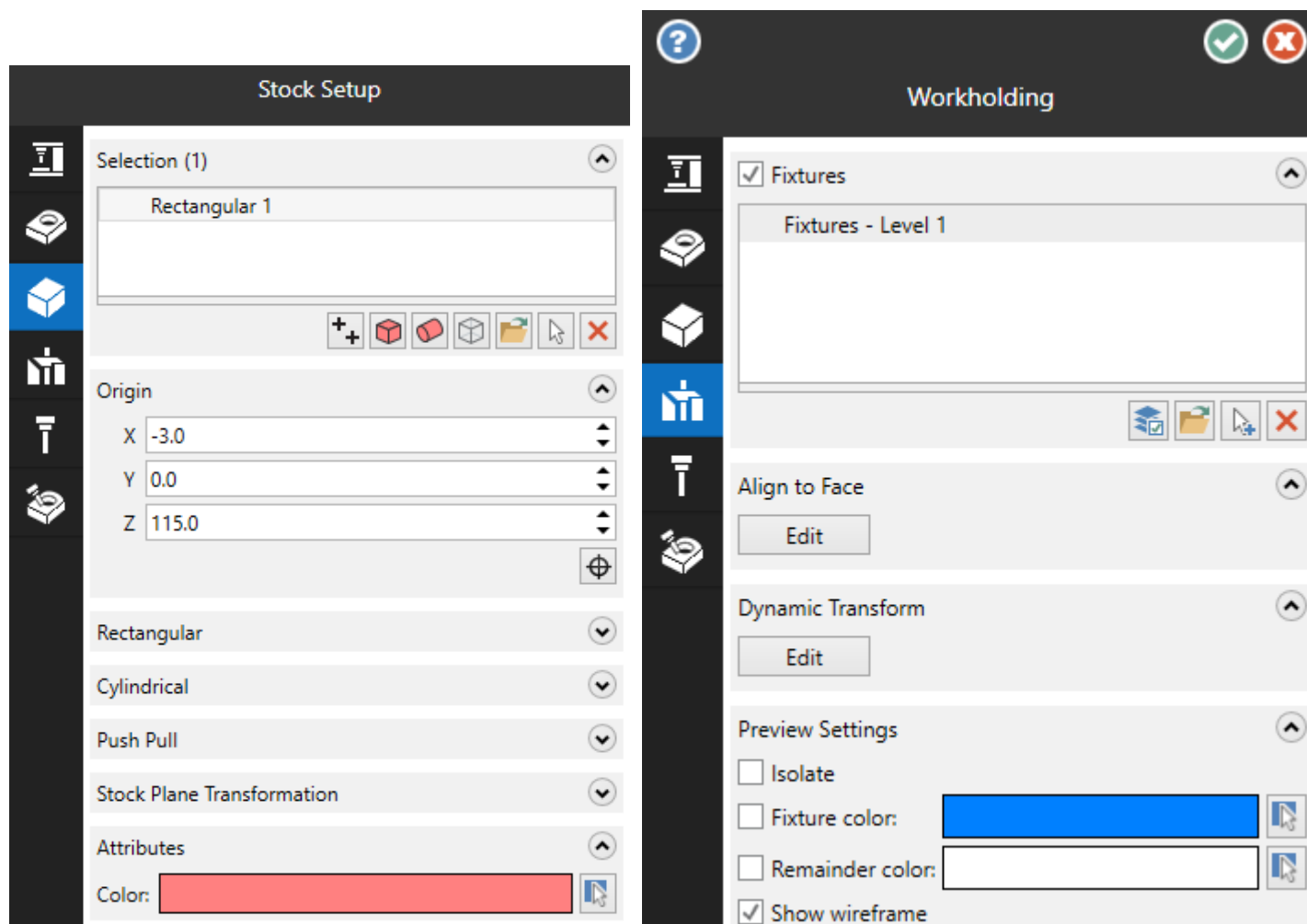

Additionally, the **Verify selected machine group** option in the **Verify selected operations** drop-down has been removed. The changes to the **Simulator Options** dialog box and the **Machine Group Setup** function panel automatically include this functionality, and it is now a redundant option.



NOTE

The **Simulator Options** dialog box includes the option to use the new **Stock Override** option upon entering simulation. You can choose between a stock model in the current part file, from a file, or selection from the graphics window.

Exporting Collision Reports

Mastercam Simulator now includes an option to export collision reports. Use the **Save Report** button to export the results to a CSV file. The generated report includes the moves, the event, the objects involved in the event, and the range of the event. This may be helpful when you need to share information with another user or technical support.

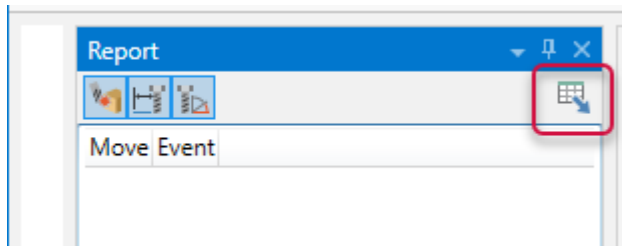

Improved Move List Pane

The Move List pane now includes new columns for **Move Type**, **Feed Rate**, **Machining Time**, and **Move Length**. Previously, you could only view the move ID and the XYZ coordinates. Use the Plus button to hide and display columns.

Move List

Mill Default mm

1 ... 3D High Speed (Waterline) • Toolpath does not include critical depths.

	Id	X	Y	Z	Move Type	Feed Rate	Move Length	Machining Time	
...	2627	-50.810	-31.689	26.143	Feed Linear Move	120.000	0.703	00:00.352	
...	2628	-50.398	-33.189	26.143	Feed Linear Move	120.000	1.555	00:00.778	
...	2629	-49.904	-34.358	26.143	Feed Arc Move	120.000	1.269	00:00.635	
...	2630	-49.731	-34.783	26.143	Feed Linear Move	120.000	0.459	00:00.229	
...	2631	-49.377	-35.692	26.143	Feed Linear Move	120.000	0.976	00:00.488	
...	2632	-49.163	-36.359	26.143	Feed Linear Move	120.000	0.701	00:00.350	
...	2633	-48.335	-41.029	26.143	Feed Arc Move	120.000	4.755	00:02.378	
...	2634	-53.681	-55.039	26.143	Feed Arc Move	120.000	15.425	00:07.712	
...	2635	-67.063	-60.645	26.143	Feed Arc Move	120.000	14.896	00:07.448	

Checking Your Tool Orientation During Simulation

When simulating a mill-turn machine, you can now check for tool orientation issues when checking for collisions. After selecting **Tool Orientation** in the **Collision Checking** drop-down, the **Reports** pane notifies you when a tool insert does not match the spindle direction.

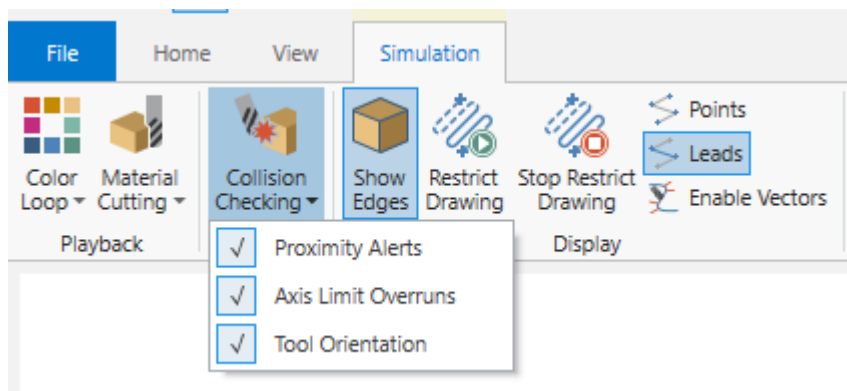

You can also select **Tool Orientation** as a **Stop Condition**, which is set on the **Home** tab. When selected, Mastercam Simulator pauses your simulation when a tool insert does not match the spindle direction.

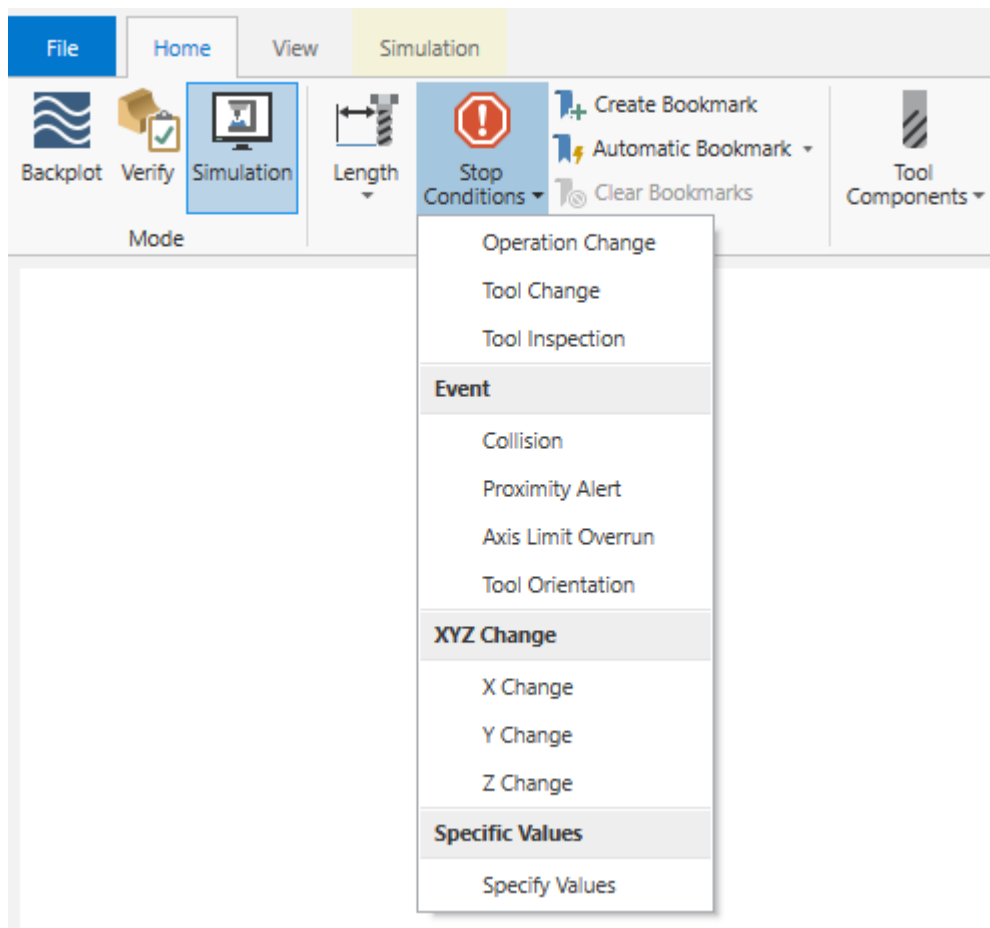

Viewing Tool Tip Positions and Comments

You can now view the current tool tip position (WCS and Tplane) in the **Move Info** pane while in Mastercam Simulator. The position is shown in XYZ coordinates. Additionally, if you enter a tool comment in the toolpath dialog box, the **Move Info** pane displays it.

Move Info	
Move Info	
Move ID	1897 of 5040
Elapsed Time	1h 16min 2.36s
Machine	5AxHeadHead
Move Type	Feed Linear Move
Operation Name	3D High Speed (Waterline)
Operation Number	ID: 1 (1 of 1)
Operation Comment	Toolpath does not include critical depths.
Tool Number	#1 - 18 Spherical / Ball-Nosed Endmill
Tool Orientation	0.000; 0.000; 1.000
Tool Tip Position (WCS)	-7.331; 24.351; 43.724
Tool Tip Position (Tplane)	-7.331; 24.351; 43.724
B-axis Angle	0.000
Axis Values	

Setting Custom Background Colors

You can now set a background color in Mastercam Simulator independent from Mastercam's color settings. Previously, the background color was inherited from Mastercam and could not be changed. Select **File, Options** inside Mastercam Simulator and use the options on the **Graphics** page to set your preferred colors.

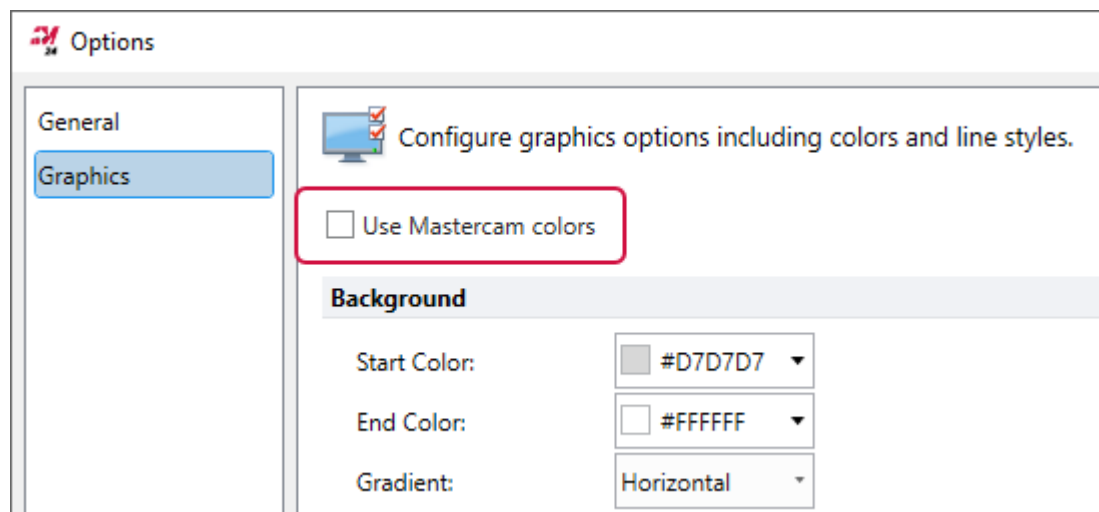

Toolpath Utility Enhancements

Listed below are major enhancements to toolpath utilities.

Changing the WCS, Cplane, or Tplane of Selected Operations

The **Edit Common Parameters** dialog box (available from the Toolpaths Manager's right-click menu) sets values for one or more toolpath parameters for several operations at the same time.

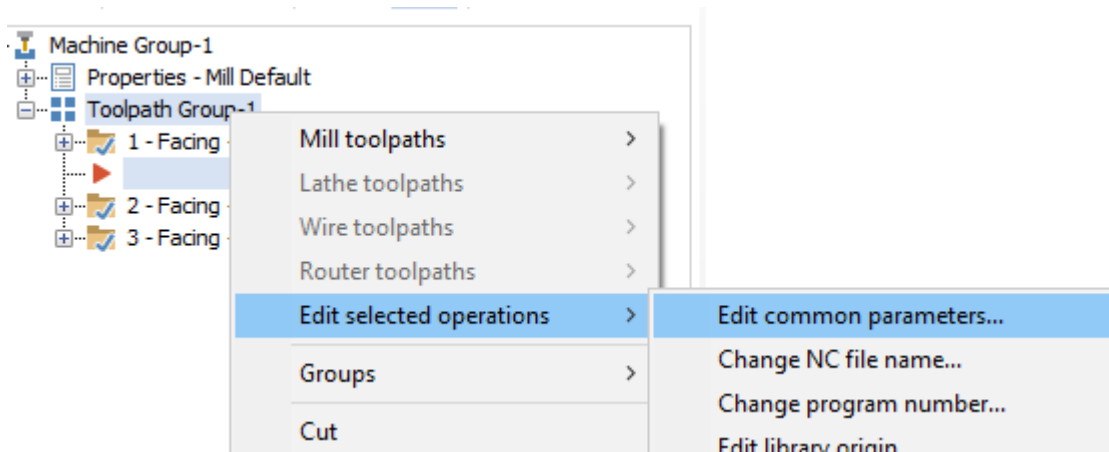

In Mastercam 2024, we have improved how we display shared planes and your ability to modify the planes of selected operations when you use this dialog box to access the Toolpath Coordinate System.

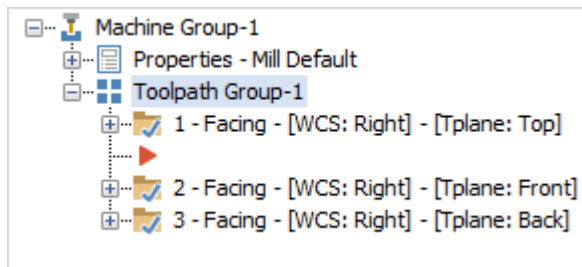

To modify the planes of multiple selected operations, click the **Planes** button in the **Edit Common Parameters** dialog box to open the **Toolpath Coordinate System** dialog box. When the dialog box opens in Mastercam 2023, Mastercam populates all the fields in the dialog box. When the dialog box opens in Mastercam 2024, Mastercam only displays the planes that are common to the operations, and planes that are not shared are left blank. This enhancement allows you to easily change any shared planes without effecting planes that are specific to individual operations.

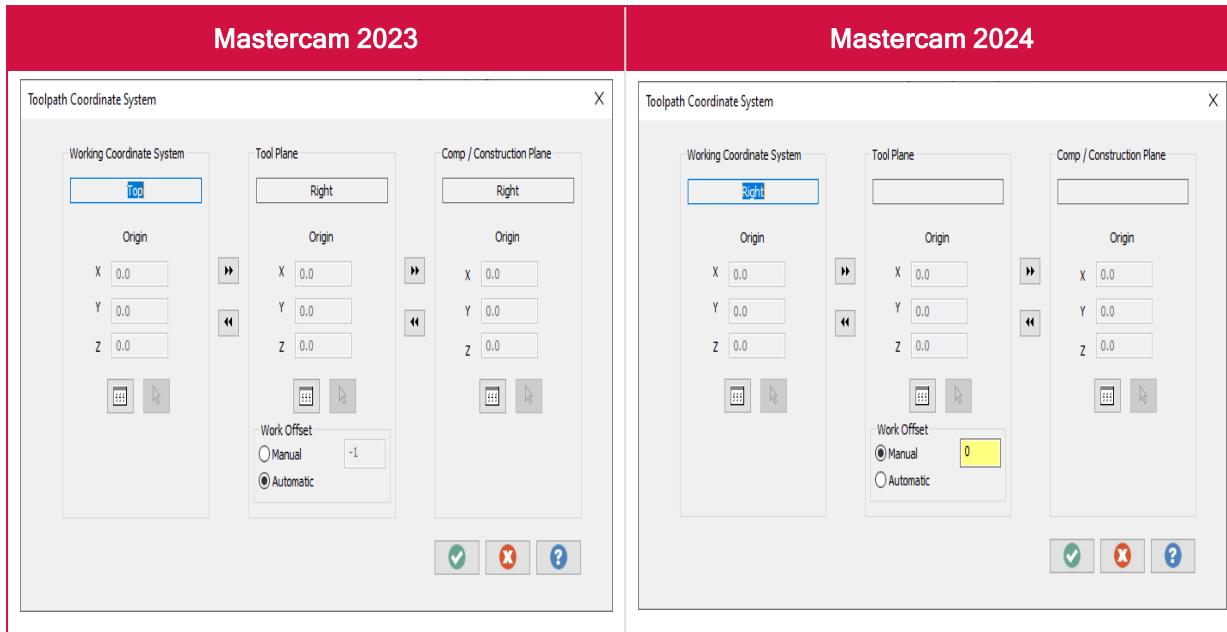

System Enhancements

Listed below are enhancements made to Mastercam's core features, including graphics, planes, and levels.

Controlling Your Graphics View with the Gview Cube

In Mastercam 2024, the traditional on-screen gnomon has been augmented with the Gview cube, a more graphical way to show plane orientation. The Gview cube, which is relative to the WCS by default, also features many options that let you control the cube, thus the on-screen representation of your part.

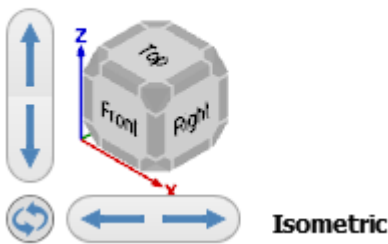

The cube itself has many interactive features. For example, double-clicking the cube fits the part to the screen (same as the **Fit** command). You can click a side, corner, or edge of the cube to switch to that view. Drag any part of the cube to change to a view, unconstrained by the preset views represented by the sides and edges.

The buttons next to the cube allow you to pan or rotate the view in various ways. The actual effect of dragging depends on whether you are holding the button down and whether you are pressing **[Alt]**, **[Ctrl]**, **[Alt+Ctrl]**, as shown in the following lists:

Arrow buttons

- Click: Pans the part up, down, left, or right.
- **[Alt]**+click: Rotates the part up, down, left, or right by a set number of degrees.

Flip/Rotate button

- Click: Flips the part 180 degrees.
- **[Shift]**+click: Flips the part 90 degrees.
- **[Shift+Alt]**+click: Flips the part - 90 degrees.
- **[Ctrl]**+click: Rotates the part counterclockwise in the view about the center of the screen by a set number of degrees.
- **[Ctrl+Alt]**+click: Rotates the part clockwise in the view about the center of the screen by a set number of degrees.

Right-click the cube to display a context menu, which includes the follow commands:

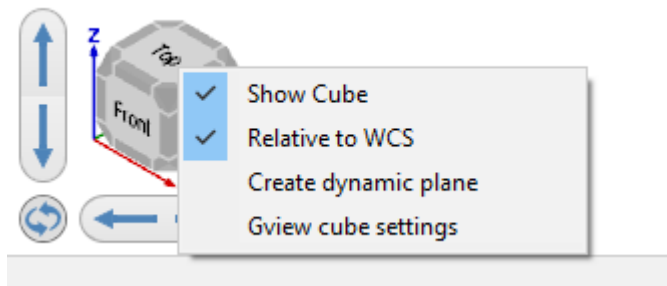

- **Show Cube:** Click this option to toggle the Gview cube on and off. When the Gview cube is on, a checkmark displays in the context menu next to **Show Cube**.
- **Relative to WCS:** Sets the world view relative to the active WCS. When enabled, a checkmark displays in the context menu next to **Relative to WCS**.
- **Create dynamic plane:** Lets you create a new plane using the Dynamic Gnomon. You can also select this function by clicking the cube's axes.
- **Settings:** Opens the **Screen** dialog box, where you can adjust the cube size, text size, opacity, arrow button pan/rotate, and arrow button rotation (degrees).

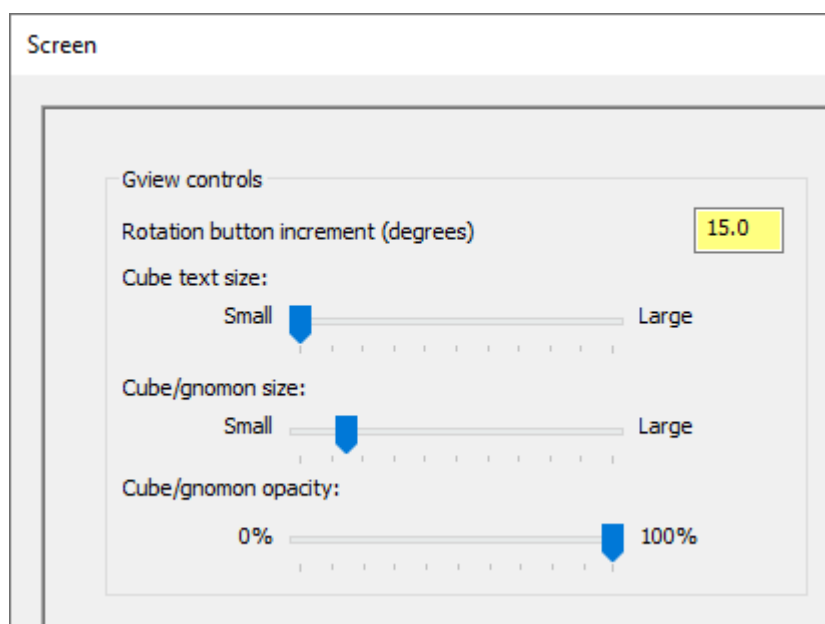

Reversing a Chain or Changing Its Side in the Graphics Area

In the graphics window, you can now reverse a chain by double-clicking it. Double-clicking the side arrow (the smaller one) changes the side of the chain. (Note that this functionality does not work with the Saw toolpath.) These new functions provide a streamlined way to manipulate chains, without having to select these options in the **Chain Manager** dialog box.

Besides reversing a chain or changing its side, you can now select a chaining arrow to have the associated entry selected in the **Chain Manager** dialog box, as shown in the picture following.

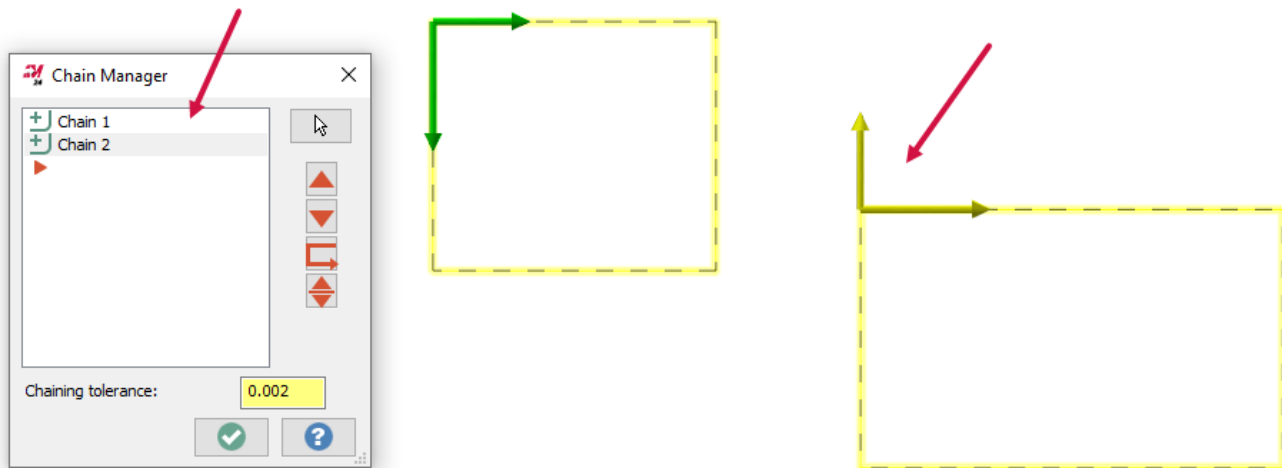

Warning of Corrupt Planes

Previously, if you opened a file with corrupt planes in Mastercam, you received no warnings or entries in the log. Now, a dialog displays informing you of the plane errors when you open a file.

System Configuration Enhancements

Listed below are enhancements made to the **System Configuration** dialog box.

Updated Screen and Spin Controls Pages

For Mastercam 2024:

- The **Screen** page has been changed to accommodate the new Gview cube settings.
- The **Wire settings** option group that was on the **Screen** page has been moved to the **Toolpaths** page.
- The **Spin Control** page has been renamed to **General** and now also contains the **MRU options** group, which used to reside on the **Screen** page.

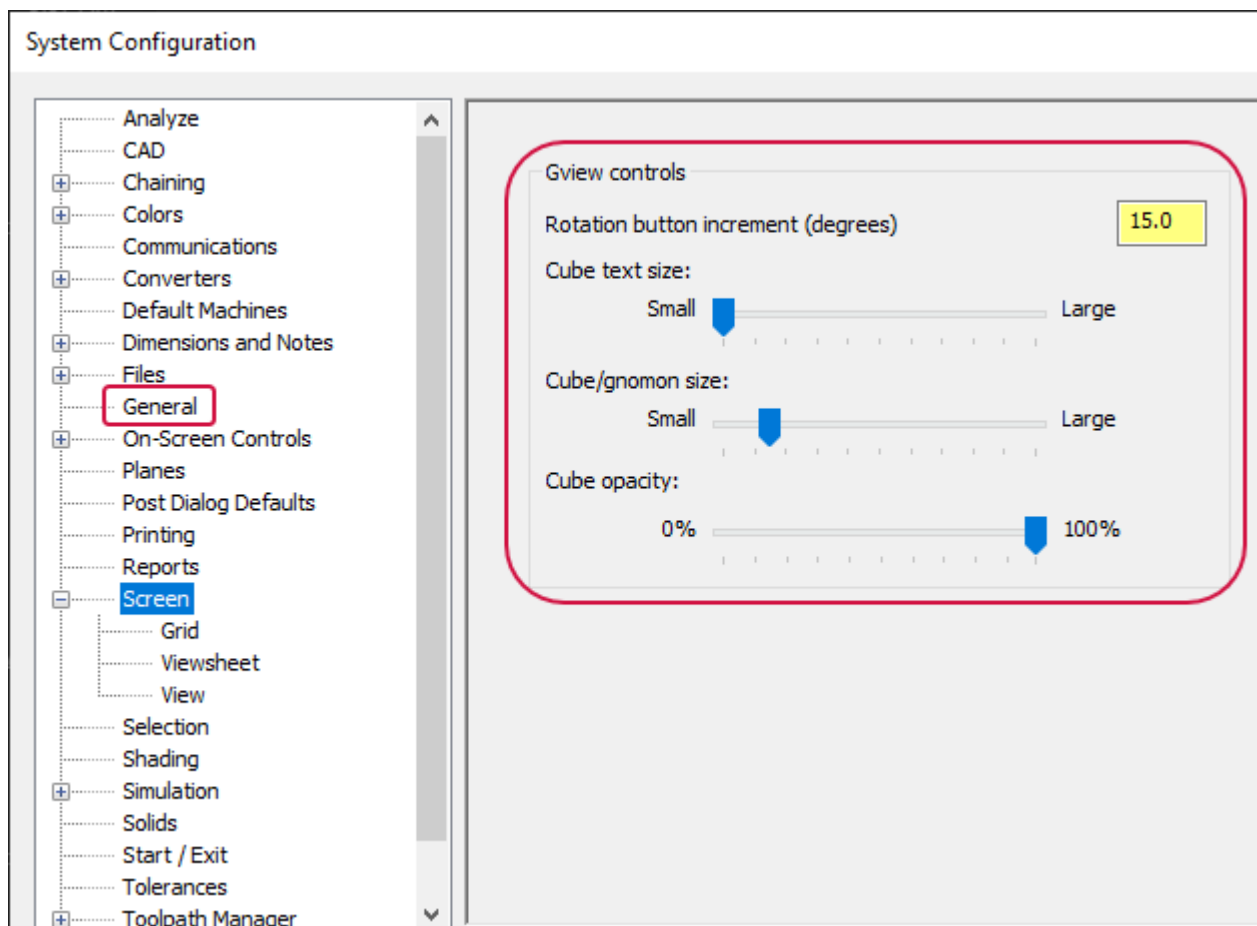

Setting Import and Export Options

The Converters page in the System Configuration dialog box has been split into two separate pages, one for import options and one for export options. In addition, the Import page contains two new options for handling GDML files.

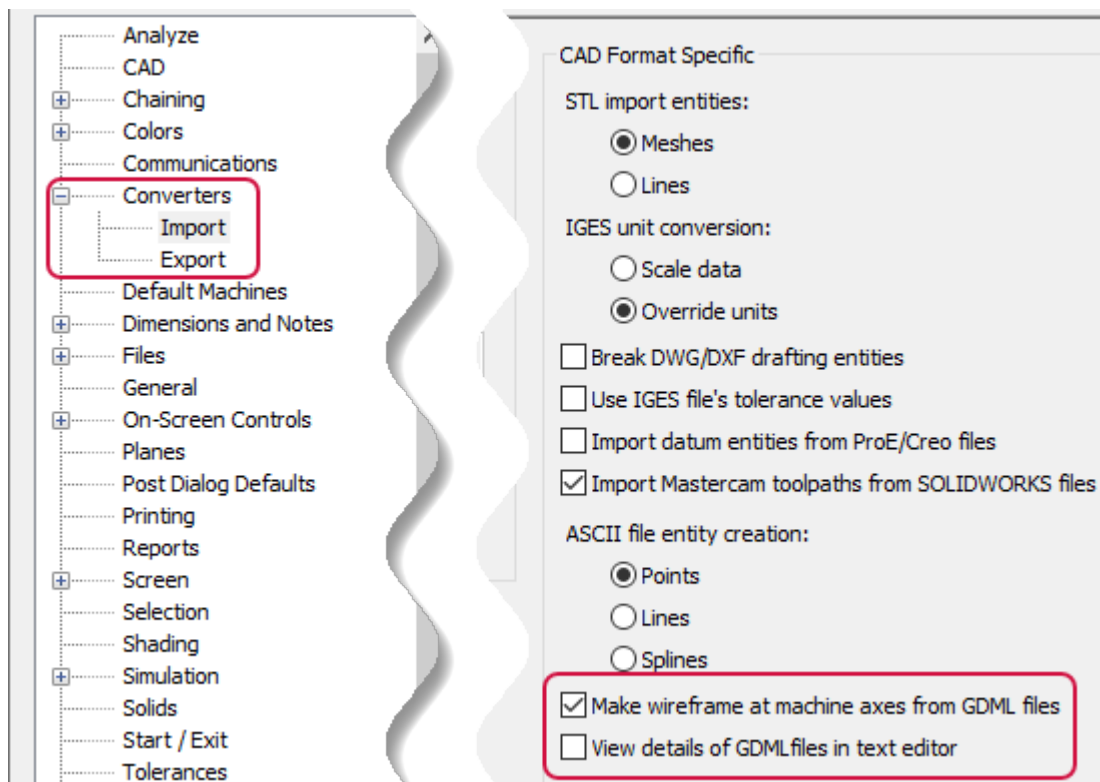

Unblank Parent Surfaces Option

Unblank parent surfaces is a new option on the Solids page of the System Configuration dialog box. This option is selected by default. When you select the option, only user-defined, blanked surfaces are available to display (Unblank). Trimmed surfaces will not be available.

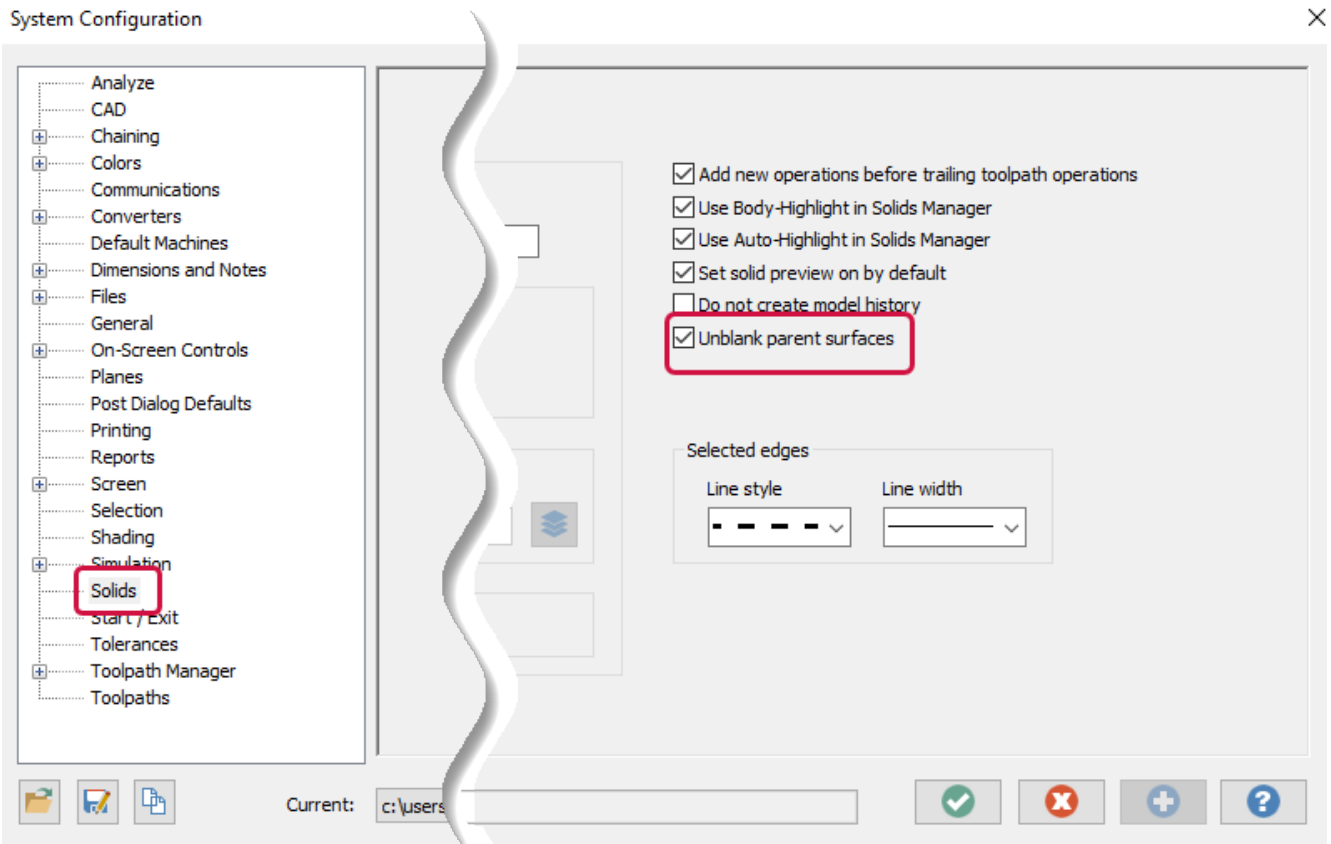

Adjusting the Translucency of Glass and Outlined Entities

Enhancements to translucency in Mastercam 2024 make it easier to control the part display. A new opacity setting for glass material is available on the **Shading** page of the **System Configuration** dialog box.

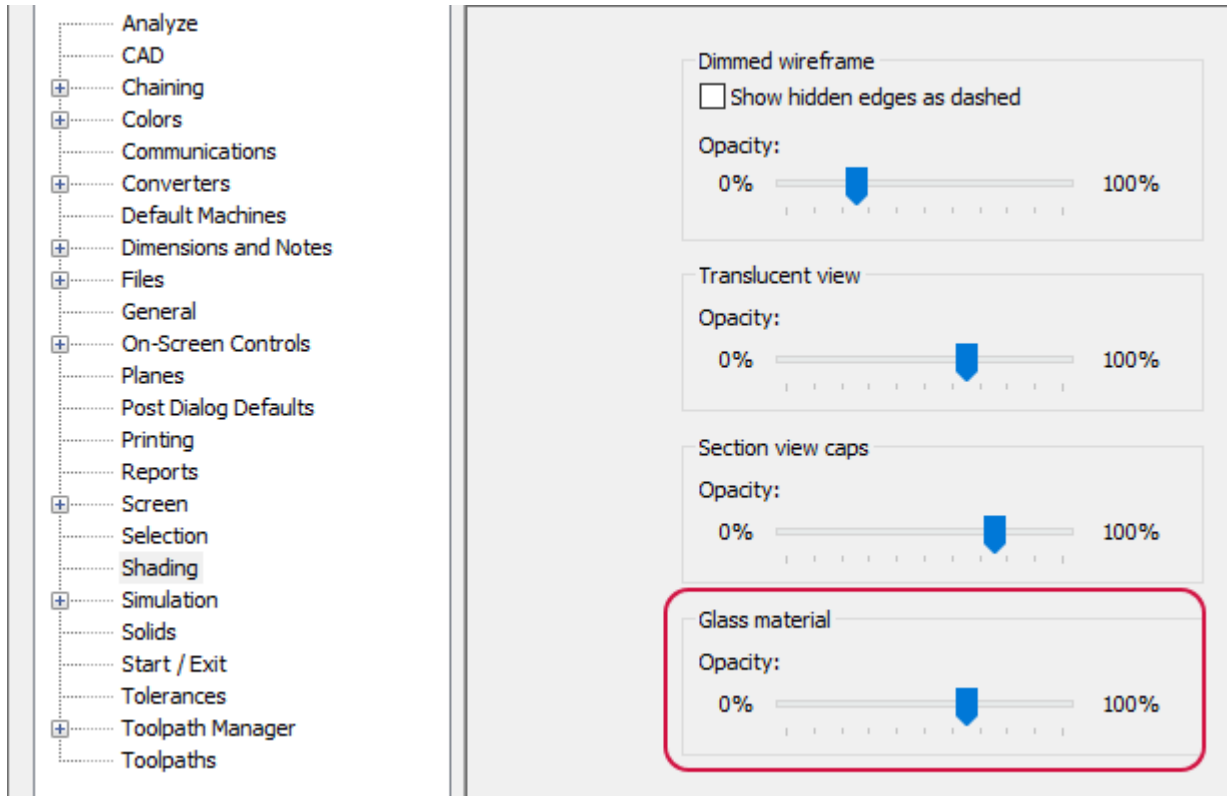

Additionally, in **Outline Shaded** mode, adjustments to the opacity of a translucent entity now affect the entity edges. In previous versions of Mastercam, the opacity setting affected the translucency of the entity but did not affect its edges. The examples below are set to **Glass level 4**.

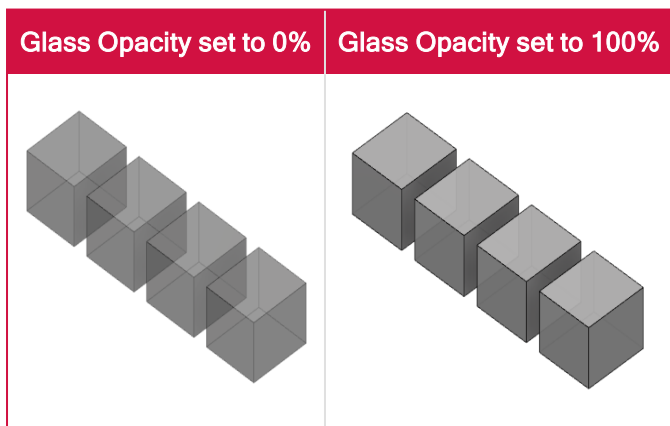

Machine Systems Enhancements

Listed below are enhancements made to Mastercam's machine systems.

Accessing Machine Definition Parameters in MP.NET

MP.NET developers have always been able to use the `Api.MPParam` function to query MP operation parameters in their MP.NET post. However, this function does not let developers query machine definition parameters or parameters for individual components. Three new functions have been added to MP.NET to provide this functionality.

- One function lets the post developer query specific components or the machine definition itself for parameter values.
- Two additional functions address the need to identify the specific component whose parameters the developer wishes to query. One function queries the axis combination in which the component resides; the second function identifies components based on their relationship with a known component.

Api.MachineDefInfo function

Use this command to query the machine definition or specific components for parameter values. This is the main function for accessing the machine definition parameters that are available to MP posts (parameters 17000-17999 and 60000-64999). Use this with a single argument to query general machine definition settings or supply a component ID as the second argument to query a specific component.

The general form of the function is as follows:

```
Api.MachineDefInfo (paramNum [, componentID])
```

The functions are defined below:

- `paramNum` is the number of the machine definition parameter to access. This can be either a number or the name of a numeric token.
- `componentID` (optional) is the ID of the component to access. For example, your machine definition might have several of the same type of component, such as linear axes, turrets, or spindles. Mastercam uses this number to select the specific machine definition component to query.

If this argument is not supplied, Mastercam will query the general machine settings. These include the information in the **General Machine Parameters** dialog box and the main **Machine Definition Manager** dialog box.

Typically you will get the desired component ID with the `Api.AxisCombo` function or the `Api.GetRelatedComponentID` function.

Api.AxisCombo function

Use this function to get the component ID of either an axis combination or a component within an axis combination. Typically the ID that is returned is used as input for the `Api.MachineDefInfo` function.

The general form of the function is as follows:

```
Api.AxisCombo (mode, spindleID, streamID [, componentType])
```

The functions are defined below:

- mode specifies the information that will be returned by the function: Title, or ComponentID.
 - Specify Title to return the name of the axis combination.
 - Specify ComponentID to return the ID of either a component in the axis combination or the axis combination itself.

Do not add quote marks around this argument.

- spindleID is the number of the spindle in the axis combination that you are querying. The SpindleID token is commonly used for this purpose.
- streamID is the number of the stream associated with the axis combination that you are querying. The StreamID token is commonly used for this purpose.

Note that in the machine definition (*.mcam-lmd file), the stream IDs are 1-based (in other words, on a dual-stream machine, the streams are 1 and 2), but inside MP.NET they are zero-based (the two streams are 0 and 1). This function uses the zero-based MP.NET stream IDs.

- ComponentType (optional) specifies the type of component in the axis combination that you are querying—for example, CAxis, Chuck, or Turret. A complete list of allowed types is presented below.
 - If you include this argument, Mastercam returns the ID of the component of that type that is present in the axis combination.
 - If you omit this argument, Mastercam returns the ID of the axis combination itself.

Specifying the component type

The allowable component types are listed here. The value specified with the function must exactly match the list below. Do not use quote marks.

- XAxis
- YAxis
- ZAxis
- AAxis
- BAxis
- CAxis
- RectangleTable
- Fixture
- Vise
- Chuck
- ColletChuck
- MultiHead
- PiggyBack
- WireUpperGuide
- WireLowerGuide

- ToolSpindle
- MultiTool
- Turret
- AggregateHead
- DrillBlock
- GangTool
- MTTurret

These are the component types that are considered to be part of an axis combination. For example, chuck jaws or collets are not considered part of the axis combination and their IDs cannot be retrieved with this function. Each axis combination should only contain one of each type of component.

- If no component of the requested type is present, then nothing will be returned.
- If a `ComponentType` argument is supplied, it does not matter what the first argument is (`Title` or `ComponentID`)—Mastercam will always return the component ID.

Api.GetRelatedComponentID function

Use this function to get the ID of a component based on its relationship with another component—for example, a child or sibling component. You can also use this function to get the ID of a component that is not in an axis combination. Typically the ID that is returned is used as input for the `Api.MachineDefInfo` function.

The general form of the function is `Api.GetRelatedComponentID (navigationType, componentID [, generation])`.

The functions are defined below:

- `navigationType` specifies the relationship between the component whose ID is supplied and the component that you are querying. Allowable values are `Parent`, `FirstChild`, `NextSibling`, `PreviousSibling`, or `Root`. Do not add quote marks around this argument.
- `componentID` is the ID of the base component in the relationship.
- `generation` (optional) represents the generation to access. If this argument is not supplied, it defaults to 1. For example, if `navigationType` is `FirstChild` and this argument is 2, then Mastercam will find the first child of original starting component and then the first child of that component, returning its ID.

Machine Group Setup Enhancements

In an on-going effort to improve **Machine Group Setup**, which was introduced in Mastercam 2023, the following improvements have been made to the overall functionality.

Viewing the Page Status

The **Machine Group Setup** panel now includes a status indicator on the page icons. You can quickly check the status of each page within the panel. This can be helpful when there is an error, but you are unable to locate which page contains it or to determine if a page is active or not.

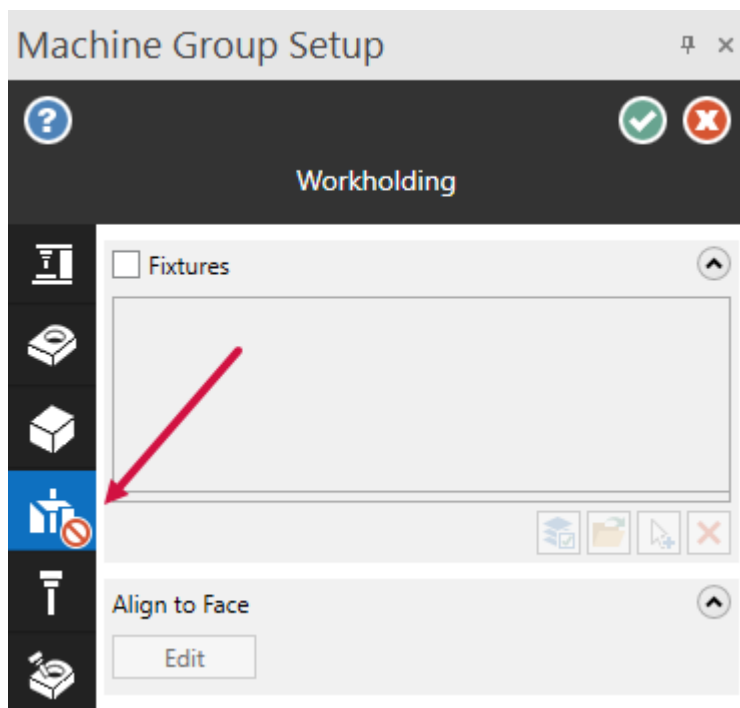

Viewing Stock Dimensions

The **Stock Setup** page has been redesigned and now includes an on-screen display, including dimensions. Additionally, you can customize the on-screen dimensions using the **Stock Dimensions** page of the **System Configuration** dialog box, under **Dimensions and Notes**.

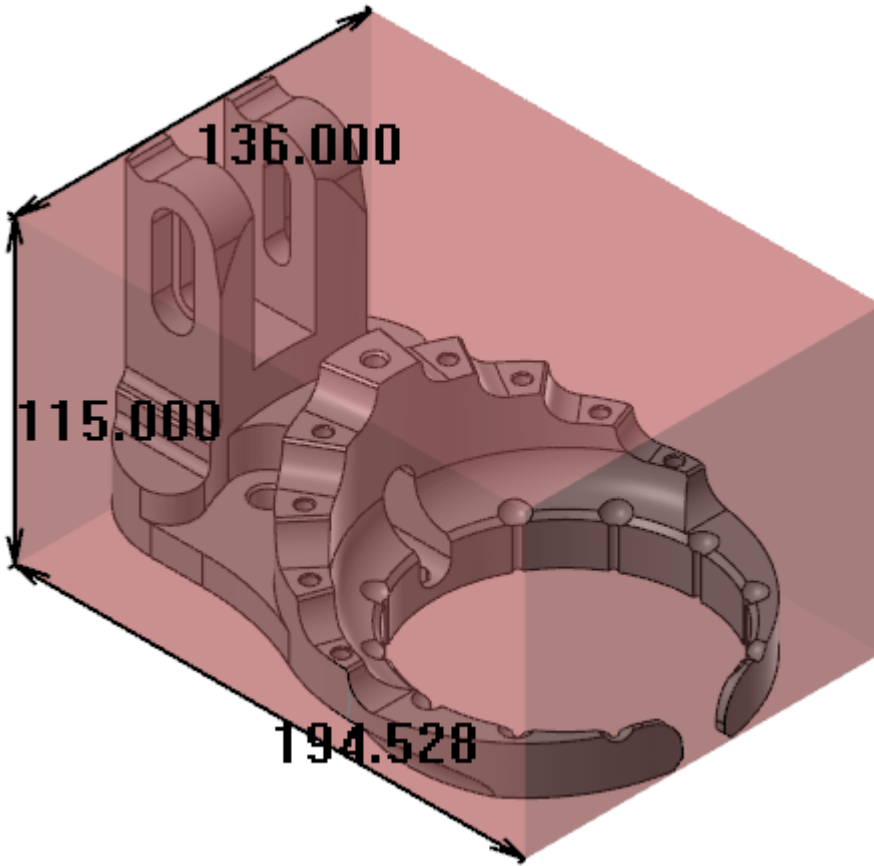

New Stock Selection Methods

Three new selection methods have been added: Add from two corners, Add rectangular stock, and Add cylindrical stock.

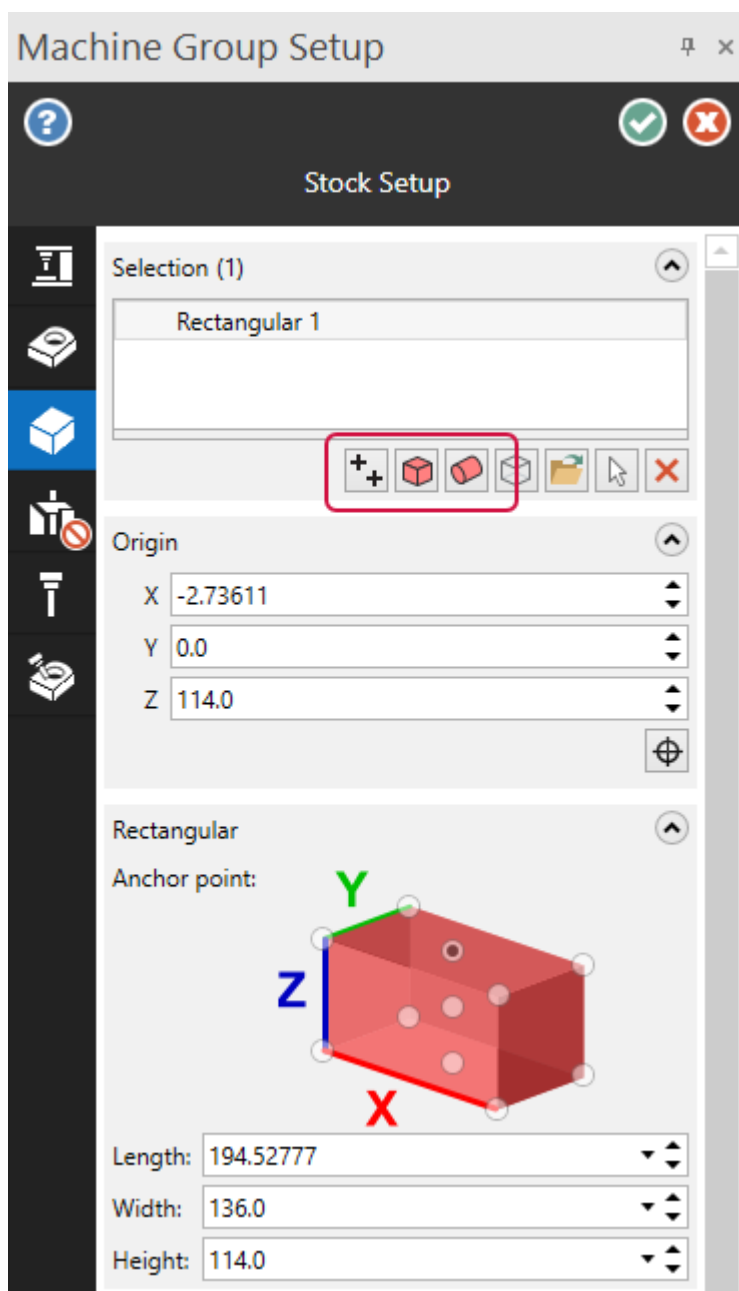

Add from two corners returns you to the graphics window to select two opposite points which represent the corners of the stock. Add rectangular stock creates a rectangle around the selected entities and Add cylindrical stock creates a cylinder around the selected entities.

Pushing and Pulling Your Stock

The Push-Pull function has been included in the **Machine Group Setup** panel. Simply click on a face to enable the use of the feature. Push-Pull allows you to extend the selected faces in the graphics window. You can set the mode to **Absolute** or **Incremental**. Additionally, you can select **Both directions** to modify both sides of the stock.

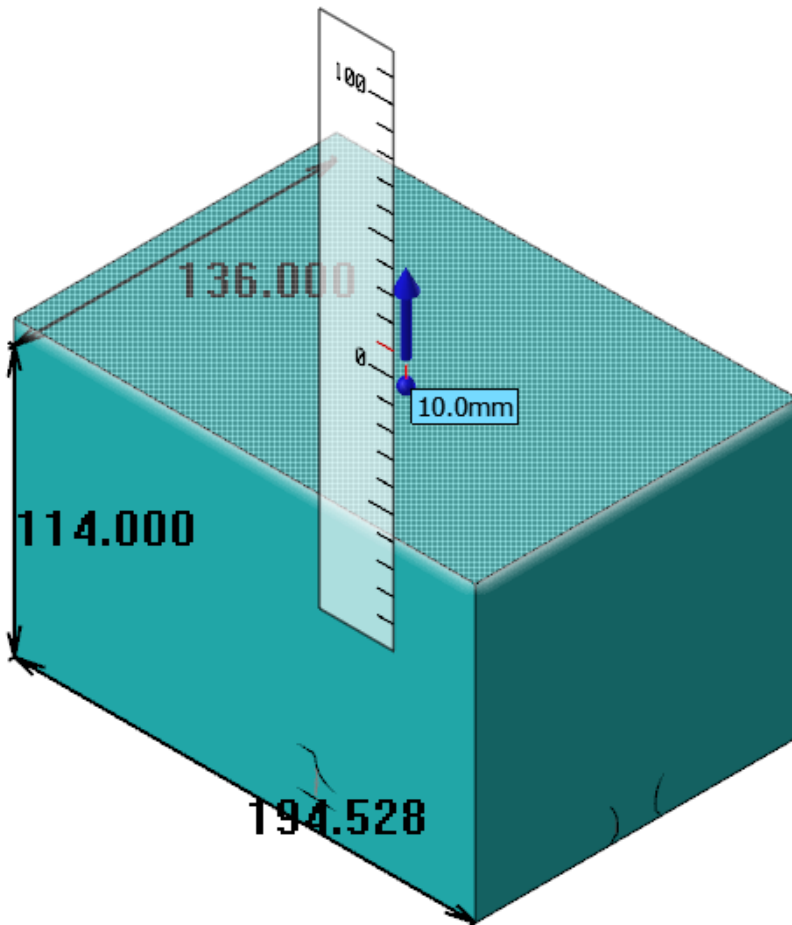

Overriding Your Stock

The new **Stock Override** option on the **Simulation** page allows you to choose which stock to use upon entering simulation. You can choose between a stock model in the current part file, from a file, or selecting from the graphics window.

Creating Mill-Turn Coolant Strategies

In Mastercam 2024, all Mill-Turn users can access the Coolant Strategy Editor. Previously, this utility was only available to licensed Developers. Use the Coolant Strategy Editor to create, edit, or delete the coolant strategies that are stored in your Mill-Turn .machine file.

Coolant strategies organize individual coolant on/off events into complete sequences. You select coolant strategies in the Sync Manager:

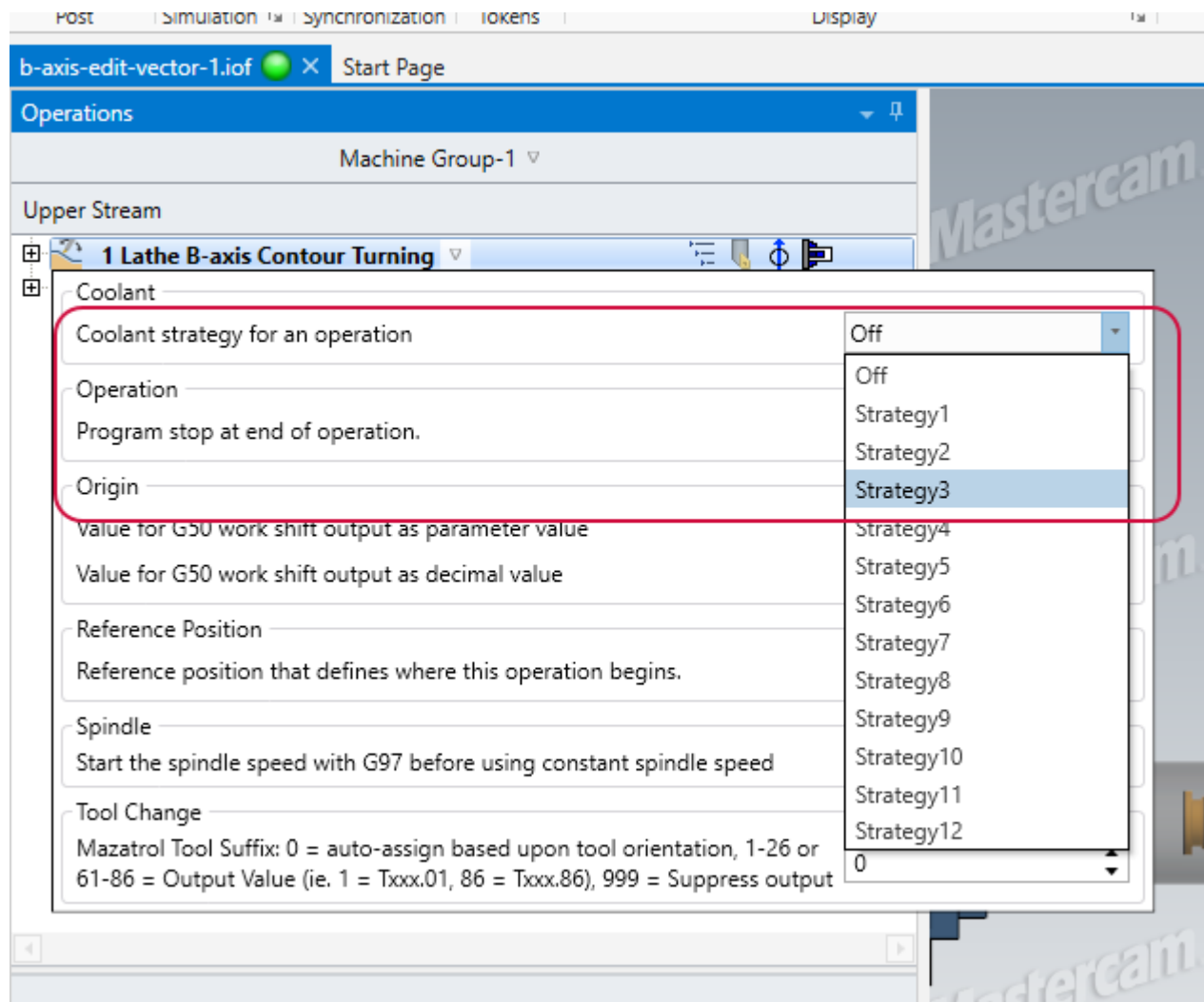

Coolant strategies are different from coolant options. For example, your machine might have three different coolant options:

- Flood coolant
- Through-tool coolant
- High-pressure coolant

Coolant strategies organize the on/off commands for one or more coolant options. For example, you might create a coolant strategy that turns on flood and through-tool coolant before the approach move, and turns both off before the retract move. You can then create a different strategy for high-pressure coolant, etc.

Follow these steps to open the Coolant Strategy Editor:

1. Open the .machine file in Code Expert.
2. If necessary, open the **Machine Explorer** panel by clicking **Machine Explorer** on the **View** ribbon.
3. Double-click the **Consumer** layer.
4. Select **Output Settings** from the **Category** list.
5. Open the **Coolant** group.
6. Click the **Open coolant strategy editor** button.

Working with the Coolant Strategy Editor

Each column in the Coolant Strategy Editor represents an individual coolant strategy. The rows represent different nodes in the approach or retract sequence where coolant options can be turned on or off. Build coolant strategies by adding coolant events to the proper row.

Strategy Name	Off	Strategy1	Strategy2	Strategy3	Strategy4
Strategy Description	Off	Flood On Before Approach / Off Before Retract	Flood On After Approach / Off Before Retract	Milling Thru-Tool On Before Approach / Off Before Retract	Milling Thru-Tool On After Approach / Off Before Retract
Physical - Before Approach	MCoolantFlood.Off	MCoolantFlood.On		MCoolantMillingSpindleThr	
Physical - After Approach			MCoolantFlood.On		MCoolantMillingSpindleThr
Physical - Before Retract		MCoolantFlood.Off	MCoolantFlood.Off	MCoolantMillingSpindleThr	MCoolantMillingSpindleThr
Physical - After Retract					
Reposition - Before Approach					
Reposition - After Approach					
Reposition - Before Retract					
Reposition - After Retract					

- Click the **Strategy Name** or **Strategy Description** to rename a strategy or edit its description. The **Strategy Description** will be visible to users as a tool tip when they select coolant strategies.
- You can create different strategies for physical tool changes and null tool changes. The **Physical** rows are used for physical tool changes and the **Reposition** rows are used for null tool changes.

- Double-click a cell to add or edit the coolant events.

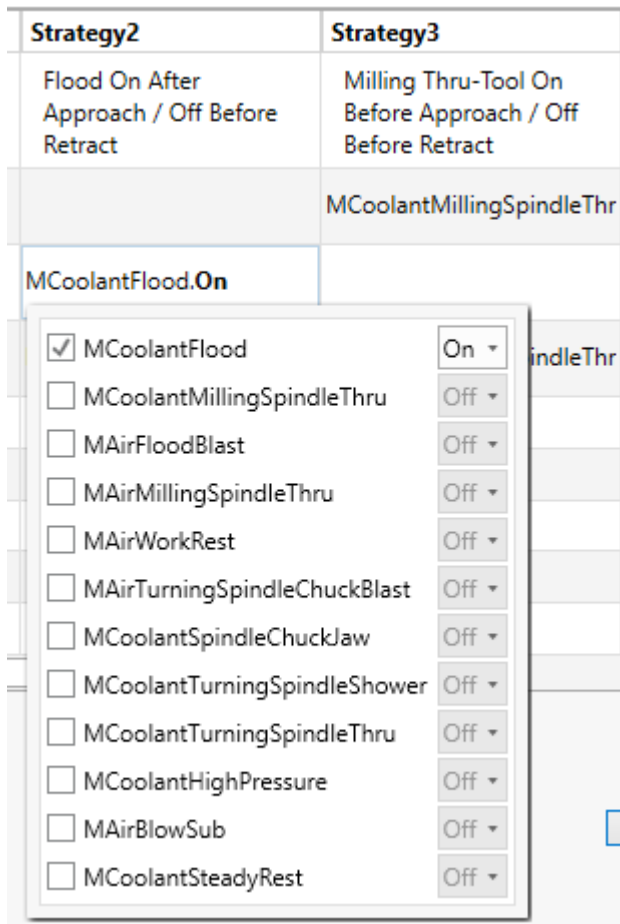

- Select a coolant option to activate it, then choose the desired On/Off event.
 - Deselect an option to remove it.
 - You can add as many different options in each cell as you wish.
 - Click on the column header to drag and reorder the columns. This also changes the order in which strategies are presented to the user in the Sync Manager.
- Make sure that each coolant option that is turned on in the strategy is also turned off later in the same strategy. The Off strategy is only used when users wish to force all coolant options off. Otherwise, each strategy should explicitly turn off each option that is turned on.

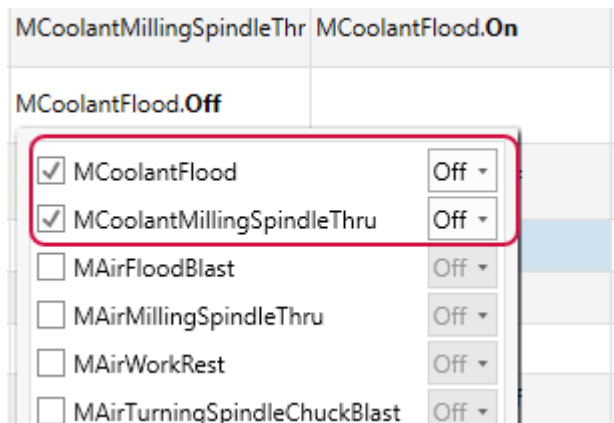

Enhancing MCO Conversion Options for Component Models

Typically, the solid models in .machine files and component libraries are converted to Mastercam's proprietary MCO format before being released. This is an encrypted mesh format that prevents the models from being edited, preserving the intellectual property of the person or company who supplied the models.

For Mastercam 2024, this functionality has been enhanced so that models can be converted to either regular Mastercam mesh entities or MCO entities. In addition, this functionality has been added to the **Machine Assembler** utility so that models can be converted automatically when the .machine file is built.

To access the new functionality, click the **Convert To Mesh** button in the Machine Definition Manager or **Component Library** dialog box. This replaces the **MCO** button found in earlier Mastercam versions. The new button opens the redesigned **Mesh Conversion Options** dialog box.

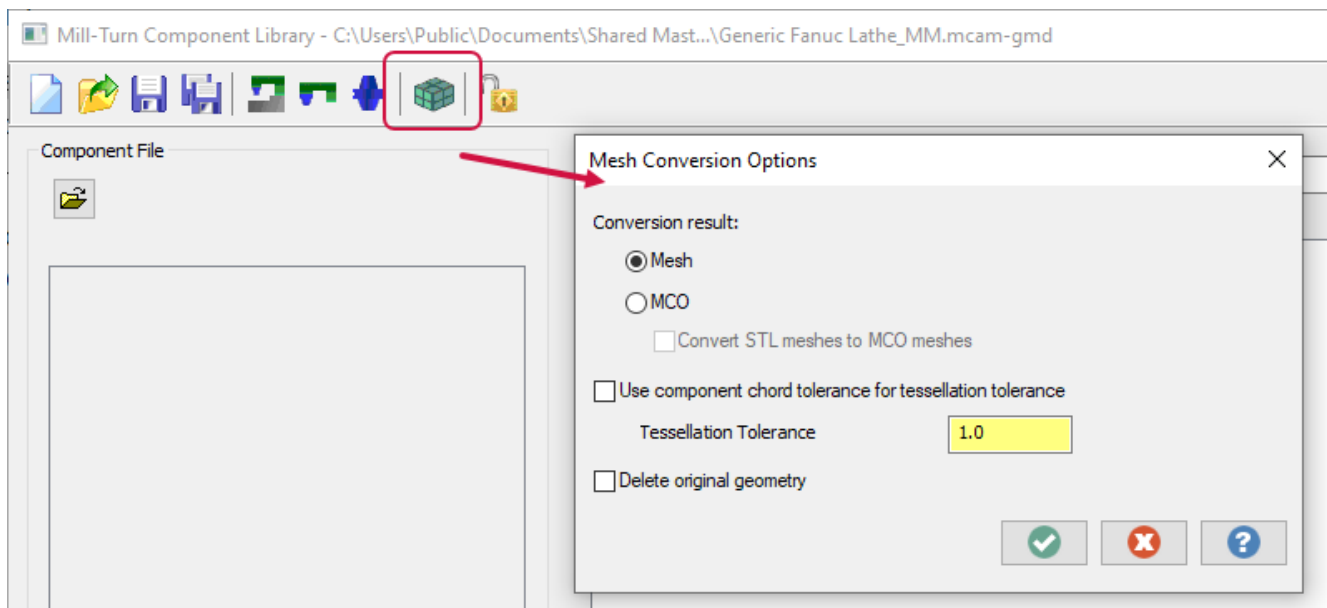

You can choose between two desired output formats: **Mesh** or **MCO**. **Mesh** converts the solids to Mastercam mesh entities. **MCO** converts the solids to an encrypted mesh format.

It is possible that the models in a machine definition or component library are already a mixture of solid and mesh entities. Select **Convert STL meshes to MCO meshes** to ensure that both solid and mesh entities are converted to MCO format. Leave this option deselected to convert only the solid entities.

Use component chord tolerance for tessellation tolerance reads the tessellation tolerance from each component's properties. Otherwise, enter the proper **Tessellation Tolerance** in the dialog box.

You can also choose to **Delete original geometry**. If you do not select this option, Mastercam leaves the original model in your file untouched. The new mesh or MCO version is placed on the same level and location as the original model, so that both entities will be on top of one another.

Licensed machine developers can also access this functionality from the **Machine Assembler** and save the conversion settings in the manifest file. You can convert a single machine definition or component library. You can also use the **Machine Assembler** to include the conversion as part of an automated build process. This lets you preserve the original solid models in your source machine definitions or component libraries.

New Options for Creating Multi-Stream Views

When organizing files in Code Expert to create a multi-stream view, new controls have been added to streamline the workflow.

- Mastercam displays the streams in the order in which the NC files are listed. Once you have selected the NC files, right-click in the list to organize the files so that the streams will display in the desired order.
- Click **Remove All** to clear the list of selected files.

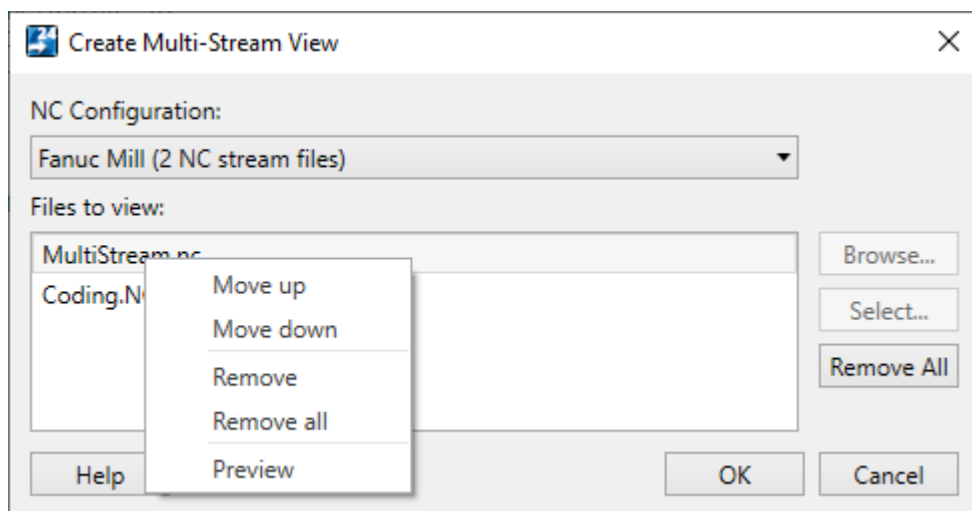

In addition, the order of the files will persist within the Code Expert session, even if you load a different part or .machine file and then return to the original NC configuration. Each NC configuration will have its own ordered list of files.

Duplicating Existing Part Handling Strategies

Machine developers who are working with .transfer files can now create a new strategy by copying an existing one. Right-click on the strategy that you want to copy and select Duplicate.

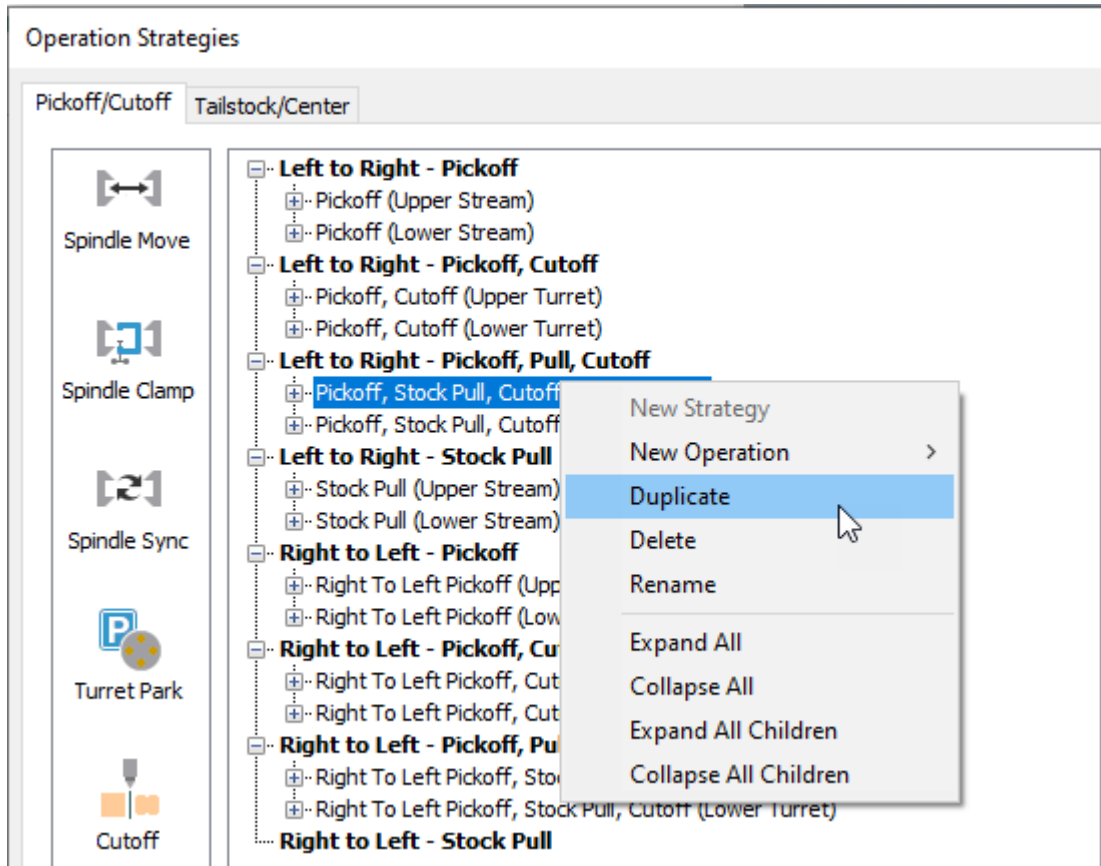

File Management Enhancements

Listed below are enhancements to file usage and converters in Mastercam.

Working with Content Files

Listed below are enhancements made to Mastercam's content files.

Updating Content Files

You no longer need to run the Migration Wizard on .mcam-content files. When you drag an old version of an .mcam-content file into Mastercam, a prompt asks if you want to update the file. If you click **Yes**, Mastercam copies the old version and puts it in a folder called **Older Versions** in the same location as the existing content file. Mastercam then extracts and updates the files.

Opening and Extracting PDF Files

When you open an .mcam-content file containing PDFs, Mastercam now prompts whether you want to open the PDFs in your default browser or PDF reader. If you click **Yes**, Mastercam opens all the PDF files listed in the **PDF Files** dialog box.

If you do not wish to be prompted each time you extract a PDF, you can deselect this option in the **Files** page of the **System Configuration** dialog box. It is selected by default.

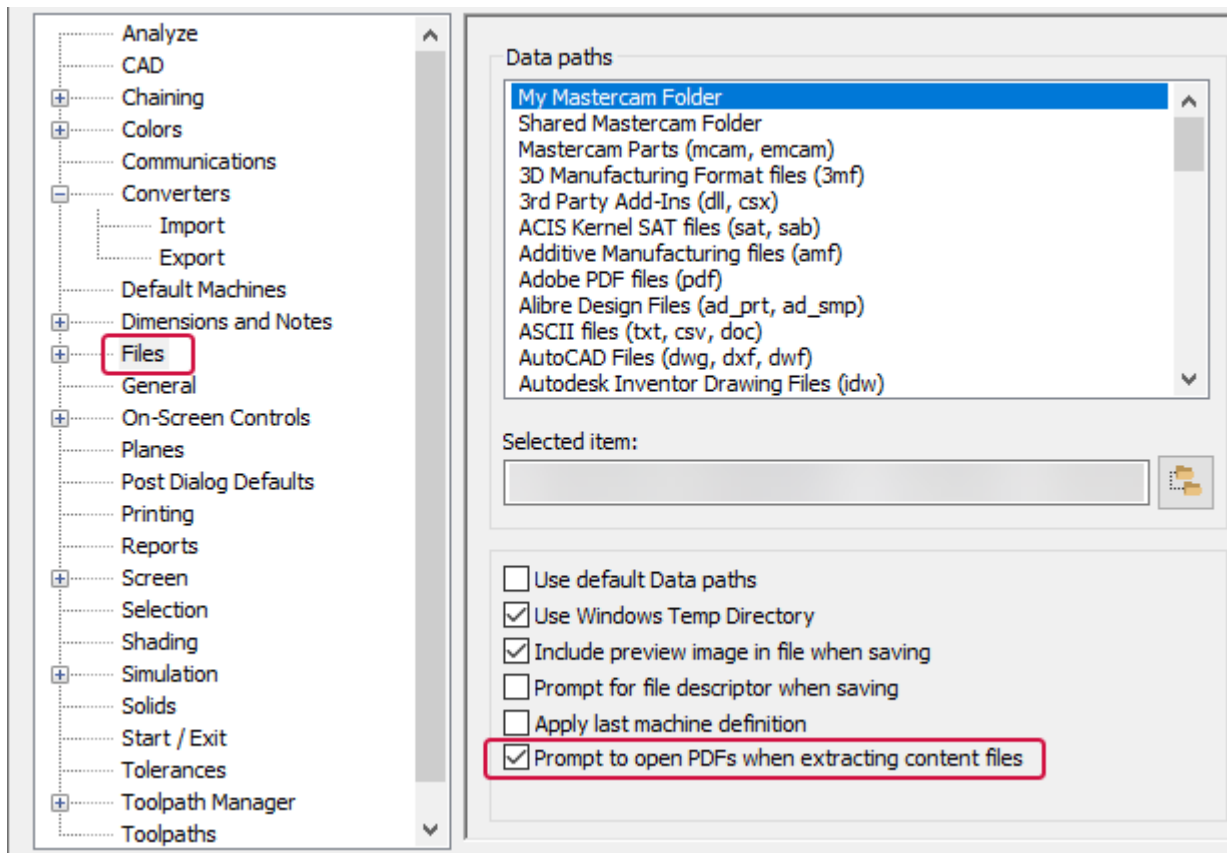

Replacing and Extracting Files

When you open an .mcam-content file containing .config or .workspace files, you can opt to replace your current .config or .workspace files with those in the content file. This will update your current session of Mastercam with the new configuration and workspace file.

Posts and Machine Environments

Listed below are the new post and machines for Mastercam 2023. These can be downloaded from the [Mastercam Tech Exchange](#).

Generic .machine Files Can No Longer be Migrated

Beginning with Mastercam 2024, Mastercam will no longer migrate generic Mill-Turn .machine files from earlier versions of Mastercam. This applies to the generic Fanuc .machine files that are installed with Mastercam and to the generic Siemens .machine files that are available on the [Mastercam Tech Exchange](#).

This is to ensure that all generic .machine files include all of the latest content and enhancements associated with the current Mastercam version. Machine files that have been migrated from earlier versions lack the most up-to-date system layer resources. This missing support can include machine components, post engine tokens, and other resources.

If your generic .machine files have custom content or features, contact your Reseller or machine developer for assistance in porting any desired modifications to the current Mastercam version.

New Posts and Machines for Mastercam 2023

The following machine environments and posts are now available for Mastercam 2023. These machines can be downloaded from the [Mastercam Tech Exchange](#).



NOTE

Not all machines and posts are available for download. Contact your local [Mastercam Reseller](#) for more information about acquiring a machine or post. You can also contact your Mastercam Reseller for more information about the Mastercam 2024 versions.

Lathe machine environments

The following machine environments have been released for Mastercam Lathe. These let users take advantage of Mastercam Mill-Turn's interface and features (including Simulation) for single-stream machines with no more than one rotary axis. These machines require only a Lathe and Mill license to run.

Machine	Control	Configurations
Haas		
ST-30 Y_C_Hybrid	Haas CNC	Single Spindle / Single Turret / Tailstock
ST-10 Y_S_Hybrid_v2		Dual Spindle / Single Turret
ST-25 Y_S_BMT65_v2		Dual Spindle / Single Turret
ST-25_C_BOT_v2		Single Spindle / Single Turret / Tailstock
ST-25_C_VDI40_v2 v		Single Spindle / Single Turret / Tailstock
ST-25_C_BMT65_v2		Single Spindle / Single Turret / Tailstock
ST-25_C_BMT65x24_v2		Single Spindle / Single Turret / Tailstock
ST-25 Y_C_BMT65_v2		Single Spindle / Single Turret / Tailstock
ST-25 Y_C_BMT65x24_v2		Single Spindle / Single Turret / Tailstock
ST-25 Y_S_BMT65x24_v2		Dual Spindle / Single Turret
ST-28 Y_S_BMT65_v2		Dual Spindle / Single Turret
ST-30 Y_S_BMT65_v2		Dual Spindle / Single Turret
ST-35 LY_C_BMT65		Single Spindle / Single Turret / Tailstock
ST-35 Y_S_BMT65x24_v2		Dual Spindle / Single Turret
Hwacheon		
Hi-TECH 230AL YSMC_BMT45x2	Fanuc 0i-MF	Dual Spindle / Single Turret
Hi-TECH 350BL YSMC		Dual Spindle / Single Turret
Mazak		
Quick Turn 200MSY 500U	Nexus 2	Dual Spindle / Single Turret
Quick Turn 250MY		Single Spindle / Single Turret / Tailstock
Takisawa		
LA-250YS	Fanuc 0i-TF	Dual Spindle / Single Turret
CMZ		
TD35 YS Z800_16st BOT	Fanuc 31i-A	Dual Spindle / Single Turret
Doosan		
PUMA 2600YII_BMT65	Fanuc i series	Single Spindle / Single Turret / Tailstock
PUMA 2600LYII_R_BMT65x24		Single Spindle / Single Turret / Tailstock / Steady Rest
PUMA 3100XLY_R_BMT65		Single Spindle / Single Turret / Tailstock / Steady Rest
PUMA 5100MLB		Single Spindle / Single Turret / Tailstock
Lynx 2100LSYB_BMT45_16st		Dual Spindle / Single Turret

Machine	Control	Configurations
Okuma		
LB4000 EX II MY x1500C	OSP-P300L	Single Spindle / Single Turret / Tailstock
LB4000 EX II L x750C		Single Spindle / Single Turret / Tailstock
LB-45III MY 2000C		Single Spindle / Single Turret / Tailstock
Genos L3000-E MYW		Dual Spindle / Single Turret
Genos L3000-e MY x1000_BMT60		Single Spindle / Single Turret / Tailstock
Genos L3000-e MY x1000_VDI		Single Spindle / Single Turret / Tailstock
DMG		
NLX4000MC 1500TSY_R_12st BOT	Mitsubishi (CELOS)	Single Spindle / Single Turret / Tailstock / Steady Rest
NLX4000MC 1500TSY_12st BOT		Single Spindle / Single Turret / Tailstock
Hardinge		
Talent 42 MSY	Fanuc 31i-A	Dual Spindle / Single Turret
Spinner		
PD 32-S_VDI 16	Siemens 840D	Dual Spindle / Single Turret
Tsugami		
M08SY	Fanuc 0i-TF	Dual Spindle / Single Turret

Mill-Turn machine environments

The following machine environments have been released for Mastercam Mill-Turn. These machines require a full Mill-Turn license.

Machine	Control	Configurations
Mazak Integrex		
i-100	SmoothX	Single Spindle / Tool Spindle / Tailstock
i-300S 1500U_R		Dual Spindle / Tool Spindle / Steady Rest
i-400S 2500U_R		Dual Spindle / Tool Spindle / Steady Rest

Machine	Control	Configurations
i-100H 590U	SmoothAI	Single Spindle / Tool Spindle / Tailstock
i-100HS 850U		Dual Spindle / Tool Spindle
i-100HST 850U		Dual Spindle / Tool Spindle / Lower Turret
I-250HS 1500U		Dual Spindle / Tool Spindle
i-250HS 1500U_R-Tandem		Dual Spindle / Tool Spindle / Tandem Steady Rest
i-250HST 1500U_9st		Dual Spindle / Tool Spindle / Lower Turret
i-350HST 1500U		Dual Spindle / Tool Spindle / Lower Turret
i-450HS 1500U		Dual Spindle / Tool Spindle / Lower Turret
i-450HS 2500U		Dual Spindle / Tool Spindle
i-450HS 2500U_R		Dual Spindle / Tool Spindle / Steady Rest
i-450HST 1500U		Dual Spindle / Tool Spindle / Lower Turret
e-500H-SII 1500U		Matrix 2
Mazak Hyper Quadrex		
200 MSY 1300U_16st VDI	Matrix 2	Dual Spindle / Dual Turret
DMG Mori		
NZX2000 800STY3	Fanuc 31i-A	Dual Spindle / Triple Turret
NZX4000 3000Y_R_B-Type		Single Spindle / Dual Turret / Tailstock / Steady Rest
NTX1000 S - Gen 2_HSK-63A		Dual Spindle / Tool Spindle
NTX2500 1500S - Gen 2		Dual Spindle / Tool Spindle
NTX3000 1500S_R - Gen 2_BMT40x12		Dual Spindle / Tool Spindle / Steady Rest
NTX3000 1500S_R - Gen 2		Dual Spindle / Tool Spindle / Steady Rest
NTX3000 3000S_R - Gen 2		Dual Spindle / Tool Spindle / Steady Rest
NT3150 DCG 1000SZ		Dual Spindle / Tool Spindle / Lower Turret
Doosan		
PUMA SMX2100ST	Fanuc 31i-A	Dual Spindle / Tool Spindle / Lower Turret
PUMA SMX3100L		Single Spindle / Tool Spindle / Tailstock
PUMA SMX3100L_R		Single Spindle / Tool Spindle / Tailstock / Steady Rest
Eurotech		
Rapido B438-Y2	Mitsubishi M700	Dual Spindle / Dual Turret
Nakamura		

Machine	Control	Configurations
MX-100	Fanuc 31i-B	Dual Spindle / Tool Spindle / Lower Turret
JX-250_1T		Dual Spindle / Tool Spindle / Lower Turret
JX-250_2T		Dual Spindle / Tool Spindle / Dual Lower Turret
Emco Powermill		
Emco HT 110 PM-SB x1700	Siemens 840D-SL	Dual Spindle / Tool Spindle
Emco HT 65 PM-SMY2B x1300_BMT55		Dual Spindle / Tool Spindle / Lower Turret
Emco HT 65 PM-SMYB x1300_VDI30		Dual Spindle / Tool Spindle / Lower Turret
Hyperturn 45-G3 SMY_BMT45x16		Dual Spindle / Dual Turret
Index		
RatioLine G220_HSK-T63	Index C200 SL	Dual Spindle / Tool Spindle / Lower Turret
Okuma		
LU3000 EX-L 2SC x600	OSP-P300L	Single Spindle / Dual Turret / Tailstock
LU3000 EX-M 2SC x1000		Single Spindle / Dual Turret / Tailstock
LT2000 EX-2T1MY		Dual Spindle / Dual Turret
LB3000 EX II MY x1200C_R		Single Spindle / Single Turret / Tailstock / Steady Rest
Tsugami		
TMA8FE	Fanuc 31i-B5	Dual Spindle / Tool Spindle

**Attention! Updates may be available.
Please refer to my.mastercam.com/product-downloads for the latest downloads.**

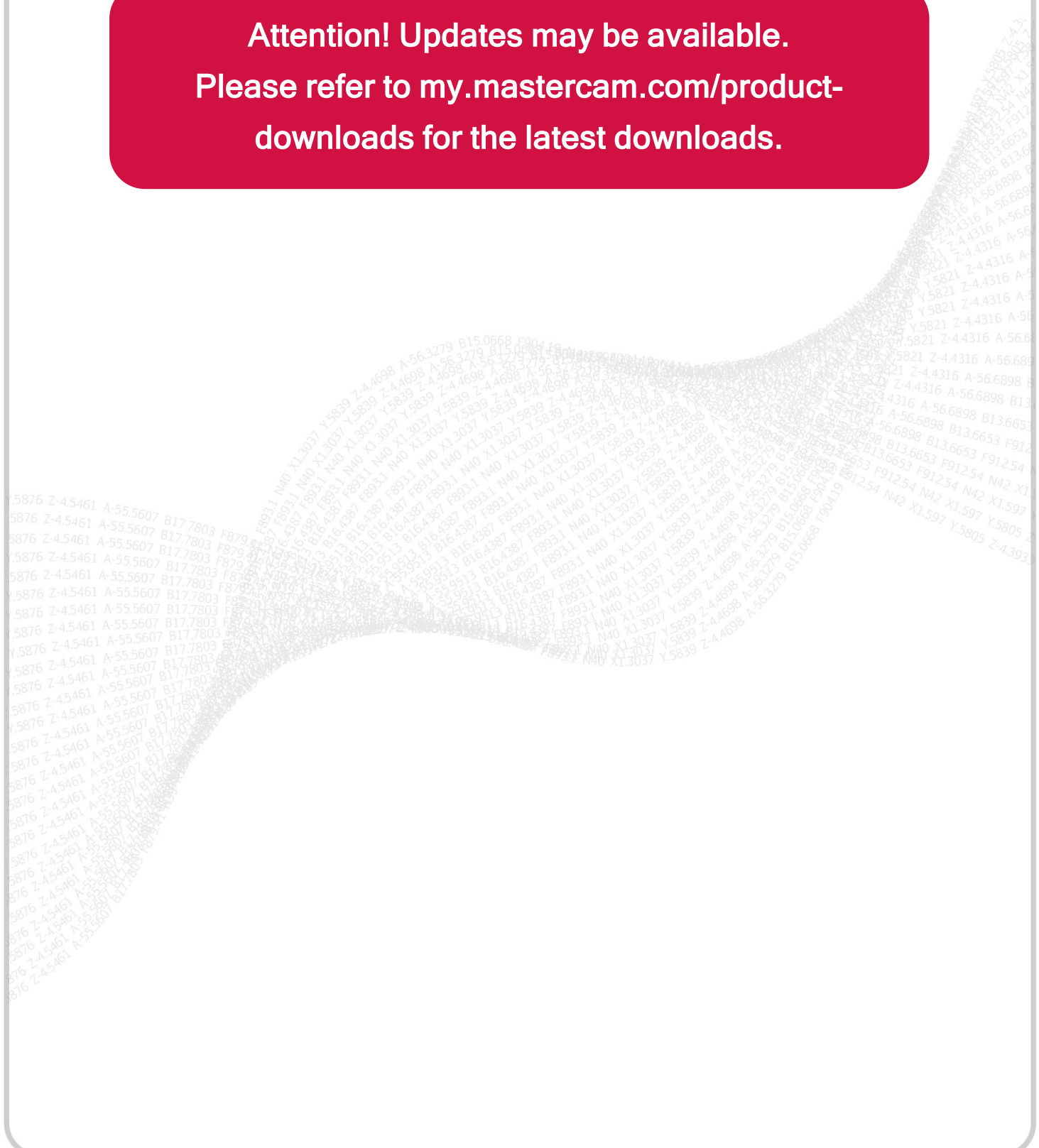

CNC Software, LLC
671 Old Post Road
Tolland, CT 06084 USA

www.mastercam.com



Mastercam® is a registered trademark of CNC Software, LLC. All other trademarks are property of their respective owners.
©1983-2023. All rights reserved.